



## AREMI



**25590/20**  
BALERO AGRICOLA CHRYSLER DODGE FORD  
SET-54



**25584/20**  
BALERO AGRICOLA PARA TRACTORES FORD 300



**15123/15245**  
BALERO AGRICOLA RASTRASERO SET-43 FORD  
MAZDA TOYOTA JD8134



**387A/382A**  
BALERO AGRICOLA RASTRASERO SET-74 GM  
DODGE FORD



**30BG05S5G 2DS**  
BALERO AIRE ACONDICIONADO FORD FS10 FX15

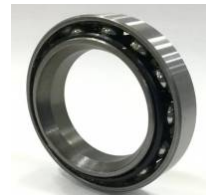

**7844651A**  
BALERO AIRE ACONDICIONADO FORD GM DODGE



**BA607A**  
BALERO ALTERNADOR FORD B-57318

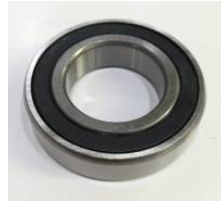

**30206**  
BALERO CONO Y TAZA FORD NISSAN TOYOTA  
HYUNDAI MITSUBISHI SUB



**30304**  
BALERO CONO Y TAZA FORD TOYOTA MITSUBISHI  
NISSAN VOLVO VW HY



**02872/20**  
BALERO CONO Y TAZA GM CHRYSLER DODGE  
FORD JEEP NISSAN SET-50



**30208**  
BALERO CONO Y TAZA GM DODGE FORD NISSAN  
HONDA MAZDA



**603049/12**  
BALERO CONO Y TAZA SET-36 GM CHRYSLER  
DODGE FORD JEEP



**603049/11**  
BALERO CONO Y TAZA SET-37 A37 GM FORD  
JEEP NISSAN MAZDA P



**104949/11**  
BALERO CONO Y TAZA SET-38 GM SILVERADO  
FORD DODGE



**25590/23**  
BALERO CONO Y TAZA SET-55 GM CHRYSLER  
DODGE FORD NISS



## AREMI



**29748/10**

BALERO CONO Y TAZA SET-56 FORD NISSAN VAGONETA



**501349/14**

BALERO CONO Y TAZA SET-69 GM FORD HONDA ISUZU PONTIAC



**15101/15245**

BALERO CONO Y TAZA SET-73 FORD 250 DODGE RAM GM PONTI



**102949/10**

BALERO CONO Y TAZA SET47 DODGE FORD EXCURSION F150 LOBO F350



**5666683/93**

BALERO DIRECCION HIDRAULICA CAMION DODGE FORD VW GMC



**R1559TV**

BALERO DOBLE RUEDA TRASERA GM CHRYSLER GMC DODGE FORD



**30205**

BALERO FORD MAZDA MITSUBICHI RENAULT TOYOTA



**30204**

BALERO FORD MAZDA NISSAN RENAULT PEUGEOT



**88128R**

BALERO FORD PICK GM SILVERADO SUBURBAN



**67048/10**

BALERO RUEDA CHEVY FORD V6 V8 ARE SET-6



## BALATAS



**D1414**

BALATA DISCO DELANTERA FORD F-150 2010 EN ADEL



**D833**

BALATA DISCO DELANTERA FORD RANGER 03-10 TETZUN



**D803**

BALATA DISCO DELANTERA FORD WINDSTAR 95-03 TETZUN



**D1140**

BALATA DISCO DELANTERO FORD CURIER 00-03 FIESTA IKON 01-11



**D664**

BALATA DISCO TRASERA FORD WINDSTAR 99-03 TETZUN



**S736**

BALATA TAMBOR TRASERA FORD CURIER TODOS TETZUN



**S752**

BALATA TAMBOR TRASERA FORD F150 99-08 F250 97-99 EXPEDITION 97-02 NAVIGATOR 98-01



**S705**

BALATA TAMBOR TRASERA FORD RANGER 95-02



**S665**

BALATA TAMBOR TRASERA FORD WINDSTAR 95-03 TETZUN



## BALEROS



### BAL-RANGER

BALERO COMPLETO FORD RANGER CARDAN CH  
88-96



### BAL-RANGER-NVO

BALERO COMPLETO FORD RANGER CARDAN  
MODELO NUEVO

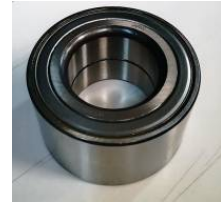

### KS-510072

BALERO DOBLE DELANTERO FORD ESCAPE 01-05



### KS-559493

BALERO DOBLE DELANTERO FORD ESCORT  
00-04



### KS-1088380

BALERO DOBLE DELANTERO FORD FIESTA



### KS-801663

BALERO DOBLE DELANTERO FORD FOCUS  
ECOSPORT POINTER S/ABS



### KS-559494

BALERO DOBLE DELANTERO FORD MYSTIQUE  
CONTOUR



### KS-579102

BALERO DOBLE DELANTERO FORD TAURUS  
WINSTAR 88-91



### KS-540733

BALERO DOBLE DELANTERO FORD TOPAZ 83-94  
CORSAR 84-89

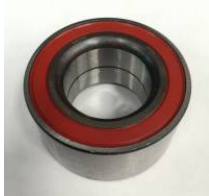

### 542186-P

BALERO DOBLE DELANTERO VW POINTER FORD  
FIESTA KA



### KS-704585

BALERO DOBLE FORD LOBO 01-05



### KS-559431

BALERO DOBLE TRASERO FORD EXPLORER 02-10  
EXPLORER SPORT TRAC 07-10



### KS-801023

BALERO DOBLE TRASERO FORD FOCUS 99-03  
FIESTA



### KS-29749-10

BALERO RUEDA DELANTERO EXT FORD T-I GHIA  
= 56



### KS-12749/10

BALERO RUEDA DELANTERO EXT FORD TOPAZ  
150 250 SET-12 A12



## BALEROS



**KS-68149-11**

BALERO RUEDA DELANTERO INTERIOR FORD  
TOPAZ 150 F250 SET-17



**KS-68149-10**

BALERO RUEDA DELANTERO INTERIOR FORD  
TOPAZ F150 F250 SET-13 A13



**KS-67048-10**

BALERO RUEDA INFERIOR CHEVY FORD V6 V8  
SET-6



**KS-SET-20**

BALERO RUEDA TRASERO FORD 70-90



**SET-10-P**

BALERO RUEDA TRASERO FORD GM DODGE  
TETZUN PREMIUM



**329013A/Q**

BALERO RUEDA TRASERO INTERIOR FORD FIESTA  
02-06 VW POINTER 00-06



## BANDAS



**BD-210**

BANDA DISTRIBUCION FORD RANGER



**K061000**

BANDA MICROV FORD ECONOLINE 95-02



**BD-294**

BANDA TIEMPO FORD CONTOUR ESCAPE SCORT



**BD-283**

BANDA TIEMPO FORD ESCORT FOCUS 4CIL 2.0L  
98-02



**BD-014**

BANDA TIEMPO FORD RANGER



**BD-276**

BANDA TIEMPO FORD RANGER 4CIL 2.5L 2.0L





## BAW



**SU300**

AMORTIGUADOR BI-TUBO C/GASOLINA NITROG  
DELANTERO (L) FORD EXPLORER 11-12



**SU296**

AMORTIGUADOR BI-TUBO C/GASOLINA NITROG  
DELANTERO (L) FORD FIESTA 14-19



**SU092**

AMORTIGUADOR BI-TUBO C/GASOLINA NITROG  
DELANTERO (L) FORD FOCUS 00-06



**SU021**

AMORTIGUADOR BI-TUBO C/GASOLINA NITROG  
DELANTERO (L) FORD FOCUS 05-11



**SU221**

AMORTIGUADOR BI-TUBO C/GASOLINA NITROG  
DELANTERO (L) FORD FOCUS 12-15



**SU298**

AMORTIGUADOR BI-TUBO C/GASOLINA NITROG  
DELANTERO (L) FORD FUSION 13-19



**SU348**

AMORTIGUADOR BI-TUBO C/GASOLINA NITROG  
DELANTERO (L) FORD IKON 12-15



**SU129**

AMORTIGUADOR BI-TUBO C/GASOLINA NITROG  
DELANTERO (L) MAZDA TRIBUTE 01-11 FORD  
ESCAPE



**SU299**

AMORTIGUADOR BI-TUBO C/GASOLINA NITROG  
DELANTERO (R) FORD EXPLORER 11-12



**SU295**

AMORTIGUADOR BI-TUBO C/GASOLINA NITROG  
DELANTERO (R) FORD FIESTA 14-19



**SU091**

AMORTIGUADOR BI-TUBO C/GASOLINA NITROG  
DELANTERO (R) FORD FOCUS 00-06



**SU020**

AMORTIGUADOR BI-TUBO C/GASOLINA NITROG  
DELANTERO (R) FORD FOCUS 05-11



**SU220**

AMORTIGUADOR BI-TUBO C/GASOLINA NITROG  
DELANTERO (R) FORD FOCUS 12-15



**SU297**

AMORTIGUADOR BI-TUBO C/GASOLINA NITROG  
DELANTERO (R) FORD FUSION 13-19



**SU347**

AMORTIGUADOR BI-TUBO C/GASOLINA NITROG  
DELANTERO (R) FORD IKON 12-15



## BAW



**SU128**

AMORTIGUADOR BI-TUBO C/GASOLINA NITROG  
DELANTERO (R) MAZDA TRIBUTE 01-11 FORD  
ESCAPE



**SU117**

AMORTIGUADOR BI-TUBO C/GASOLINA NITROG  
DELANTERO FORD COURIER 00-12 FORD FIESTA  
IKON



**SU137**

AMORTIGUADOR BI-TUBO C/GASOLINA NITROG  
DELANTERO FORD E150 92-06



**SU263**

AMORTIGUADOR BI-TUBO C/GASOLINA NITROG  
DELANTERO FORD ECOSPORT 03-12



**SU303**

AMORTIGUADOR BI-TUBO C/GASOLINA NITROG  
DELANTERO FORD EXPEDITION 07-13 LINCOLN  
NAVIGA



**SU361**

AMORTIGUADOR BI-TUBO C/GASOLINA NITROG  
DELANTERO FORD EXPEDITION 14-17 FORD F150  
14-1



**SU233**

AMORTIGUADOR BI-TUBO C/GASOLINA NITROG  
DELANTERO FORD EXPEDITION 97-02 FORD F150  
97-0



**SU097**

AMORTIGUADOR BI-TUBO C/GASOLINA NITROG  
DELANTERO FORD EXPLORER 95-01 FORD  
EXPLORER SP



**SU214**

AMORTIGUADOR BI-TUBO C/GASOLINA NITROG  
DELANTERO FORD F150 09-13



**SU278**

AMORTIGUADOR BI-TUBO C/GASOLINA NITROG  
DELANTERO FORD F150 09-13 FORD LOBO 09-13



**SU260**

AMORTIGUADOR BI-TUBO C/GASOLINA NITROG  
DELANTERO FORD FIESTA 03-12



**SU136**

AMORTIGUADOR BI-TUBO C/GASOLINA NITROG  
DELANTERO FORD KA 01-08



**SU161**

AMORTIGUADOR BI-TUBO C/GASOLINA NITROG  
DELANTERO FORD RANGER 13-17



**SU139**

AMORTIGUADOR BI-TUBO C/GASOLINA NITROG  
DELANTERO FORD RANGER 98-11 MAZDA B2300  
98-04



**SU113**

AMORTIGUADOR BI-TUBO C/GASOLINA NITROG  
DELANTERO FORD WINDSTAR 95-04



## BAW



**SU236**

AMORTIGUADOR BI-TUBO C/GASOLINA NITROG  
TRASERO FORD COURIER 00-12



**SU141**

AMORTIGUADOR BI-TUBO C/GASOLINA NITROG  
TRASERO FORD E150 92-06



**SU264**

AMORTIGUADOR BI-TUBO C/GASOLINA NITROG  
TRASERO FORD ECOSPORT 03-12



**SU084**

AMORTIGUADOR BI-TUBO C/GASOLINA NITROG  
TRASERO FORD ESCAPE 01-07 MAZDA TRIBUTE  
01-07



**SU304**

AMORTIGUADOR BI-TUBO C/GASOLINA NITROG  
TRASERO FORD EXPEDITION 07-19 LINCOLN  
NAVIGATO



**SU351**

AMORTIGUADOR BI-TUBO C/GASOLINA NITROG  
TRASERO FORD EXPLORER 11-19



**SU241**

AMORTIGUADOR BI-TUBO C/GASOLINA NITROG  
TRASERO FORD F150 04-08 FORD LOBO 04-08  
FORD F



**SU085**

AMORTIGUADOR BI-TUBO C/GASOLINA NITROG  
TRASERO FORD F150 90-96 FORD F250 80-97  
FORD F



**SU234**

AMORTIGUADOR BI-TUBO C/GASOLINA NITROG  
TRASERO FORD F150 97-03 FORD LOBO 97-03



**SU283**

AMORTIGUADOR BI-TUBO C/GASOLINA NITROG  
TRASERO FORD FIESTA 03-12



**SU116**

AMORTIGUADOR BI-TUBO C/GASOLINA NITROG  
TRASERO FORD FIESTA 11-13 MAZDA 2 11-15



**SU350**

AMORTIGUADOR BI-TUBO C/GASOLINA NITROG  
TRASERO FORD FIESTA 14-19 FORD FIGO 16-19



**SU105**

AMORTIGUADOR BI-TUBO C/GASOLINA NITROG  
TRASERO FORD FIESTA IKON 98-07



**SU022**

AMORTIGUADOR BI-TUBO C/GASOLINA NITROG  
TRASERO FORD FOCUS 05-11 MAZDA 3 10-11  
MAZDA 3







**SU222**

AMORTIGUADOR BI-TUBO C/GASOLINA NITROG  
TRASERO FORD FOCUS 12-18



## BAW

|  |   |  |
|--|---|--|
|  <p><b>SU359</b><br/>AMORTIGUADOR BI-TUBO C/GASOLINA NITROG TRASERO FORD FUSION 13-19</p> |  <p><b>SU218</b><br/>AMORTIGUADOR BI-TUBO C/GASOLINA NITROG TRASERO FORD RANGER 89-09 FORD BRONCO II 89-90</p>     | <p><b>SU415</b><br/>AMORTIGUADOR BI-TUBO CON GAS NITROGENO DEL. (L) FORD EDGE 11-14 LINCOLN MKX 11-15</p>  |
| <p><b>SU414</b><br/>AMORTIGUADOR BI-TUBO CON GAS NITROGENO DEL. (R) FORD EDGE 11-14 LINCOLN MKX 11-15</p>  | <p><b>SU444</b><br/>AMORTIGUADOR BI-TUBO CON GAS NITROGENO DEL. FORD EXPLORER 06-10 FORD EXPLORER SPORT T</p>   | <p><b>SU432</b><br/>AMORTIGUADOR BI-TUBO CON GAS NITROGENO DEL. FORD TRANSIT 07-13</p>   |
| <p><b>SU427</b><br/>AMORTIGUADOR BI-TUBO CON GAS NITROGENO TRAS. FORD EXPLORER 06-10 FORD EXPLORER SPORT</p>   | <p><b>SU399</b><br/>AMORTIGUADOR BI-TUBO CON GAS NITROGENO TRAS. FORD IKON 12-15</p>  | <p><b>SU425</b><br/>AMORTIGUADOR BI-TUBO CON GAS NITROGENO TRAS. FORD TRANSIT 07-13</p>  |
| <p><b>SU449</b><br/>AMORTIGUADOR BI-TUBO CON GAS NITROGENO TRAS. FORD TRANSIT 07-13</p>  | <p><b>SU505</b><br/>AMORTIGUADOR TRASERO FORD FIGO 20-21</p>  |  <p><b>BP1645C</b><br/>BALATA DELANTERA FORD ESCAPE 13-19 LINCOLN MKC 17-19</p>                   |
| <p><b>BP1414C</b><br/>BALATA DELANTERA FORD EXPEDITION 10-17 FORD F150 10-17 FORD F150 SVT RAPTOR 10-14 FOR</p>  |  <p><b>BP1158C</b><br/>BALATA DELANTERA FORD EXPLORER 06-10 FORD EXPLORER SPORT TRAC 07-10 MERCURY MOUNTAINE</p> |  <p><b>BP1083C</b><br/>BALATA DELANTERA FORD F150 04-09 FORD LOBO 04-09 LINCOLN MARK LT 06-08</p> |



## BAW



**BP1454C**  
BALATA DELANTERA FORD FIESTA 11-19



**BP1920C**  
BALATA DELANTERA FORD FIGO 16-20



**BP1563C**  
BALATA DELANTERA FORD FOCUS 12-18 FORD  
ESCAPE 13-19



**BP833C**  
BALATA DELANTERA FORD RANGER 03-11 FORD  
EXPLORER 02-05 FORD EXPLORER SPORT 01-03  
MAZD

**BP1676C**  
BALATA DELANTERA FORD RANGER 13-21

**BP1787C**  
BALATA DELANTERA FORD TRANSIT 14-19



**BP1044C**  
BALATA DELANTERA MAZDA 3 04-13 MAZDA 5  
06-15 FORD FOCUS 05-07 FORD ECOSPORT  
13-17 VOL

**BN1116**  
BUJE DELANTERO (2) FORD FOCUS 12-18 FORD  
ESCAPE 13-19

**BN1115**  
BUJE DELANTERO (2) FORD TRANSIT 07-13

**BN1172**  
BUJE DELANTERO FORD EXPEDITION 97-02 FORD  
F150 97-03 FORD F250 97-99 FORD LOBO 97-03

**BN1180**  
BUJE DELANTERO FORD EXPEDITION 97-02 FORD  
F150 97-03 FORD F250 97-99 FORD LOBO 97-03

**BN1104**  
BUJE DELANTERO FORD EXPLORER 06-19 FORD  
EXPLORER SPORT TRAC 07-10 FORD FLEX 10-19  
LIN

**BN1173**  
BUJE DELANTERO FORD EXPLORER 98-01 FORD  
EXPLORER SPORT 01-03 FORD EXPLORER SPORT  
TRAC

**BN1108**  
BUJE DELANTERO FORD FIGO 16-20

**BN1048**  
BUJE DELANTERO INFERIOR POSTERIOR FORD  
ESCAPE 20-21 FORD BRONCO SPORT 21-21  
LINCOLN C



## BAW

|   |   |   |
|---|---|---|
| <b>BN1130</b><br>BUJE DELANTERO(2) FORD RANGER 13-19  | <b>BN1117</b><br>BUJE TRASERO (2) FORD FOCUS 07-11 FORD<br>FOCUS 12-18 FORD FOCUS 12-18                     | <b>BN1090</b><br>BUJE TRASERO FORD ECOSPORT 13-18   |
| <b>BN1091</b><br>BUJE TRASERO FORD FIGO 16-18   | <b>BN1103</b><br>GOMA VARILLA ESTABILIZADORA DELANTERA<br>FORD FIESTA 11-19                                 | <b>CM244</b><br>HORQUILLA DELANTERO INFERIOR (L) FORD<br>CONTOUR 95-98 MERCURY COUGAR 99-02<br>MERCURY MYST |
| <b>CM246</b><br>HORQUILLA DELANTERO INFERIOR (L) FORD<br>CONTOUR 98-00 MERCURY COUGAR 99-02<br>MERCURY MYST | <b>CM161</b><br>HORQUILLA DELANTERO INFERIOR (L) FORD<br>CROWN VICTORIA 03-11 LINCOLN TOWN CAR<br>03-11 MER | <b>CM165</b><br>HORQUILLA DELANTERO INFERIOR (L) FORD<br>CROWN VICTORIA 95-02 LINCOLN TOWN CAR<br>95-02 MER |
| <b>CM1317</b><br>HORQUILLA DELANTERO INFERIOR (L) FORD<br>ECOSPORT 13-20                                    | <b>CM970</b><br>HORQUILLA DELANTERO INFERIOR (L) FORD<br>EDGE 07-14 LINCOLN MKX 07-15                       | <b>CM1380</b><br>HORQUILLA DELANTERO INFERIOR (L) FORD<br>EDGE 15-20 LINCOLN MKX 16-18                      |
| <b>CM248</b><br>HORQUILLA DELANTERO INFERIOR (L) FORD<br>ESCAPE 01-12 MAZDA TRIBUTE 01-11 MERCURY<br>MARINE | <b>CM250</b><br>HORQUILLA DELANTERO INFERIOR (L) FORD<br>ESCAPE 01-12 MAZDA TRIBUTE 01-11 MERCURY<br>MARINE | <b>CM998</b><br>HORQUILLA DELANTERO INFERIOR (L) FORD<br>ESCAPE 13-19                                       |



## BAW

|  |  |   |
|--|--|---|
| <p><b>CM1442</b><br/>HORQUILLA DELANTERO INFERIOR (L) FORD ESCAPE 20-21 LINCOLN CORSAIR 20-21 FORD BRONCO</p>  | <p><b>CM592</b><br/>HORQUILLA DELANTERO INFERIOR (L) FORD ESCORT 84-90 FORD TEMPO 84-94 MERCURY TOPAZ 84-</p>  | <p><b>CM311</b><br/>HORQUILLA DELANTERO INFERIOR (L) FORD EXPEDITION 03-06 LINCOLN NAVIGATOR 03-06</p>        |
| <p><b>CM313</b><br/>HORQUILLA DELANTERO INFERIOR (L) FORD EXPEDITION 07-13 FORD F150 09-13 LINCOLN MARK L</p>  | <p><b>CM1125</b><br/>HORQUILLA DELANTERO INFERIOR (L) FORD EXPEDITION 14-17 FORD F150 14-14 LINCOLN NAVIGA</p> | <p><b>CM305</b><br/>HORQUILLA DELANTERO INFERIOR (L) FORD EXPEDITION 97-02 FORD F150 97-03 FORD F250 97-9</p> |
| <p><b>CM1508</b><br/>HORQUILLA DELANTERO INFERIOR (L) FORD EXPEDITION 97-02 FORD F150 97-03 FORD F250 97-9</p> | <p><b>CM267</b><br/>HORQUILLA DELANTERO INFERIOR (L) FORD EXPLORER 06-10 FORD EXPLORER SPORT TRAC 07-10 M</p>  | <p><b>CM1100</b><br/>HORQUILLA DELANTERO INFERIOR (L) FORD EXPLORER 11-19</p>                                 |
| <p><b>CM1396</b><br/>HORQUILLA DELANTERO INFERIOR (L) FORD EXPLORER 20-21</p>                                  | <p><b>CM1450</b><br/>HORQUILLA DELANTERO INFERIOR (L) FORD EXPLORER 20-21</p>                                  | <p><b>CM259</b><br/>HORQUILLA DELANTERO INFERIOR (L) FORD EXPLORER 95-01 FORD EXPLORER SPORT 01-03 FORD E</p> |
| <p><b>CM317</b><br/>HORQUILLA DELANTERO INFERIOR (L) FORD F150 04-08 FORD FX4 04-08 FORD LOBO 04-08 LINCO</p>  | <p><b>CM1153</b><br/>HORQUILLA DELANTERO INFERIOR (L) FORD F150 15-20</p>                                      | <p><b>CM943</b><br/>HORQUILLA DELANTERO INFERIOR (L) FORD FIESTA 11-19 FORD FIGO 16-20 MAZDA 2 11-15</p>      |





## BAW

|  |  |  |
|--|--|--|
| <p><b>CM272</b><br/>HORQUILLA DELANTERO INFERIOR (L) FORD FIVE HUNDRED 05-07 FORD FREESTYLE 05-07 MERCURY</p>  | <p><b>CM276</b><br/>HORQUILLA DELANTERO INFERIOR (L) FORD FOCUS 00-04</p>                                  | <p><b>CM282</b><br/>HORQUILLA DELANTERO INFERIOR (L) FORD FOCUS 04-11</p>                                      |
| <p><b>CM278</b><br/>HORQUILLA DELANTERO INFERIOR (L) FORD FOCUS 07-07 VOLVO S40 04-06</p>                      | <p><b>CM280</b><br/>HORQUILLA DELANTERO INFERIOR (L) FORD FOCUS 08-11 VOLVO C30 07-10 VOLVO S40 06-11</p>  | <p><b>CM1030</b><br/>HORQUILLA DELANTERO INFERIOR (L) FORD FOCUS 12-18 FORD FOCUS 12-18 FORD FOCUS 12-18 F</p> |
| <p><b>CM1048</b><br/>HORQUILLA DELANTERO INFERIOR (L) FORD FOCUS 13-18 FORD FOCUS 12-18</p>                    | <p><b>CM319</b><br/>HORQUILLA DELANTERO INFERIOR (L) FORD FREESTAR 04-07</p>                               | <p><b>CM550</b><br/>HORQUILLA DELANTERO INFERIOR (L) FORD FUSION 06-12 LINCOLN MKZ 07-12 LINCOLN ZEPHYR 0</p>  |
| <p><b>CM1291</b><br/>HORQUILLA DELANTERO INFERIOR (L) FORD FUSION 13-20 FORD FUSION 13-16 LINCOLN MKZ 13-2</p> | <p><b>CM1293</b><br/>HORQUILLA DELANTERO INFERIOR (L) FORD FUSION 17-18</p>                                | <p><b>CM289</b><br/>HORQUILLA DELANTERO INFERIOR (L) FORD MUSTANG 05-10 FORD MUSTANG 07-10</p>                 |
| <p><b>CM291</b><br/>HORQUILLA DELANTERO INFERIOR (L) FORD MUSTANG 10-14 FORD MUSTANG 10-14</p>                 | <p><b>CM556</b><br/>HORQUILLA DELANTERO INFERIOR (L) FORD PROBE 93-97 MAZDA 626 93-97 MAZDA MX-6 93-97</p> | <p><b>CM1465</b><br/>HORQUILLA DELANTERO INFERIOR (L) FORD RANGER 13-21</p>                                    |



## BAW

|   |   |   |
|---|---|---|
| <p><b>CM590</b><br/>HORQUILLA DELANTERO INFERIOR (L) FORD<br/>TAURUS 86-95 MERCURY SABLE 86-95</p>                    | <p><b>CM293</b><br/>HORQUILLA DELANTERO INFERIOR (L) FORD<br/>TAURUS 98-07 MERCURY SABLE 98-05</p>                    | <p><b>CM524</b><br/>HORQUILLA DELANTERO INFERIOR (L) FORD<br/>THUNDERBIRD 89-97 LINCOLN MARK VIII 93-98<br/>MERCU</p> |
| <p><b>CM1558</b><br/>HORQUILLA DELANTERO INFERIOR (L) FORD<br/>TRANSIT COURIER 21-22</p>                              | <p><b>CM847</b><br/>HORQUILLA DELANTERO INFERIOR (L) FORD<br/>WINDSTAR 95-98</p>                                      | <p><b>CM849</b><br/>HORQUILLA DELANTERO INFERIOR (L) FORD<br/>WINDSTAR 99-03</p>                                      |
| <p><b>CM243</b><br/>HORQUILLA DELANTERO INFERIOR (R) FORD<br/>CONTOUR 95-98 MERCURY COUGAR 99-02<br/>MERCURY MYST</p> | <p><b>CM245</b><br/>HORQUILLA DELANTERO INFERIOR (R) FORD<br/>CONTOUR 98-00 MERCURY COUGAR 99-02<br/>MERCURY MYST</p> | <p><b>CM160</b><br/>HORQUILLA DELANTERO INFERIOR (R) FORD<br/>CROWN VICTORIA 03-11 LINCOLN TOWN CAR<br/>03-11 MER</p> |
| <p><b>CM164</b><br/>HORQUILLA DELANTERO INFERIOR (R) FORD<br/>CROWN VICTORIA 95-02 LINCOLN TOWN CAR<br/>95-02 MER</p> | <p><b>CM1316</b><br/>HORQUILLA DELANTERO INFERIOR (R) FORD<br/>ECOSPORT 13-20</p>                                     | <p><b>CM969</b><br/>HORQUILLA DELANTERO INFERIOR (R) FORD<br/>EDGE 07-14 LINCOLN MKX 07-15</p>                        |
| <p><b>CM1379</b><br/>HORQUILLA DELANTERO INFERIOR (R) FORD<br/>EDGE 15-20 LINCOLN MKX 16-18</p>                       | <p><b>CM247</b><br/>HORQUILLA DELANTERO INFERIOR (R) FORD<br/>ESCAPE 01-12 MAZDA TRIBUTE 01-11 MERCURY<br/>MARINE</p> | <p><b>CM249</b><br/>HORQUILLA DELANTERO INFERIOR (R) FORD<br/>ESCAPE 01-12 MAZDA TRIBUTE 01-11 MERCURY<br/>MARINE</p> |



## BAW

|   |  |  |
|---|--|--|
| <p><b>CM997</b><br/>HORQUILLA DELANTERO INFERIOR (R) FORD<br/>ESCAPE 13-19</p>  | <p><b>CM1441</b><br/>HORQUILLA DELANTERO INFERIOR (R) FORD<br/>ESCAPE 20-21 LINCOLN CORSAIR 20-21 FORD<br/>BRONCO</p>  | <p><b>CM591</b><br/>HORQUILLA DELANTERO INFERIOR (R) FORD<br/>ESCORT 84-90 FORD TEMPO 84-94 MERCURY<br/>TOPAZ 84-</p>  |
| <p><b>CM310</b><br/>HORQUILLA DELANTERO INFERIOR (R) FORD<br/>EXPEDITION 03-06 LINCOLN NAVIGATOR 03-06</p>            | <p><b>CM312</b><br/>HORQUILLA DELANTERO INFERIOR (R) FORD<br/>EXPEDITION 07-13 FORD F150 09-13 LINCOLN<br/>MARK L</p>  | <p><b>CM1124</b><br/>HORQUILLA DELANTERO INFERIOR (R) FORD<br/>EXPEDITION 14-17 FORD F150 14-14 LINCOLN<br/>NAVIGA</p> |
| <p><b>CM304</b><br/>HORQUILLA DELANTERO INFERIOR (R) FORD<br/>EXPEDITION 97-02 FORD F150 97-03 FORD F250<br/>97-9</p> | <p><b>CM1507</b><br/>HORQUILLA DELANTERO INFERIOR (R) FORD<br/>EXPEDITION 97-02 FORD F150 97-03 FORD F250<br/>97-9</p> | <p><b>CM266</b><br/>HORQUILLA DELANTERO INFERIOR (R) FORD<br/>EXPLORER 06-10 FORD EXPLORER SPORT TRAC<br/>07-10 M</p>  |
| <p><b>CM1099</b><br/>HORQUILLA DELANTERO INFERIOR (R) FORD<br/>EXPLORER 11-19</p>                                     | <p><b>CM1395</b><br/>HORQUILLA DELANTERO INFERIOR (R) FORD<br/>EXPLORER 20-21</p>                                      | <p><b>CM1449</b><br/>HORQUILLA DELANTERO INFERIOR (R) FORD<br/>EXPLORER 20-21</p>                                      |
| <p><b>CM258</b><br/>HORQUILLA DELANTERO INFERIOR (R) FORD<br/>EXPLORER 95-01 FORD EXPLORER SPORT 01-03<br/>FORD E</p> | <p><b>CM316</b><br/>HORQUILLA DELANTERO INFERIOR (R) FORD F150<br/>04-08 FORD FX4 04-08 FORD LOBO 04-08 LINCO</p>      | <p><b>CM1152</b><br/>HORQUILLA DELANTERO INFERIOR (R) FORD F150<br/>15-20 FORD EXPEDITION 18-21 LINCOLN NAVIGA</p>     |



## BAW

|   |  |  |
|---|--|--|
| <p><b>CM941</b><br/>HORQUILLA DELANTERO INFERIOR (R) FORD FIESTA 11-19 FORD FIGO 16-20 MAZDA 2 11-15</p>      | <p><b>CM271</b><br/>HORQUILLA DELANTERO INFERIOR (R) FORD FIVE HUNDRED 05-07 FORD FREESTYLE 05-07 MERCURY</p>  | <p><b>CM275</b><br/>HORQUILLA DELANTERO INFERIOR (R) FORD FOCUS 00-04</p>                                  |
| <p><b>CM281</b><br/>HORQUILLA DELANTERO INFERIOR (R) FORD FOCUS 04-11</p>                                     | <p><b>CM277</b><br/>HORQUILLA DELANTERO INFERIOR (R) FORD FOCUS 07-07 VOLVO S40 04-06</p>                      | <p><b>CM279</b><br/>HORQUILLA DELANTERO INFERIOR (R) FORD FOCUS 08-11 VOLVO C30 07-10 VOLVO S40 06-11</p>  |
| <p><b>CM1029</b><br/>HORQUILLA DELANTERO INFERIOR (R) FORD FOCUS 12-18 FORD FOCUS 12-18</p>                   | <p><b>CM1047</b><br/>HORQUILLA DELANTERO INFERIOR (R) FORD FOCUS 13-18 FORD FOCUS 12-18</p>                    | <p><b>CM318</b><br/>HORQUILLA DELANTERO INFERIOR (R) FORD FREESTAR 04-07</p>                               |
| <p><b>CM549</b><br/>HORQUILLA DELANTERO INFERIOR (R) FORD FUSION 06-12 LINCOLN MKZ 07-12 LINCOLN ZEPHYR 0</p> | <p><b>CM1290</b><br/>HORQUILLA DELANTERO INFERIOR (R) FORD FUSION 13-20 FORD FUSION 13-16 LINCOLN MKZ 13-2</p> | <p><b>CM1292</b><br/>HORQUILLA DELANTERO INFERIOR (R) FORD FUSION 17-18</p>                                |
| <p><b>CM288</b><br/>HORQUILLA DELANTERO INFERIOR (R) FORD MUSTANG 05-10 FORD MUSTANG 07-10</p>                | <p><b>CM290</b><br/>HORQUILLA DELANTERO INFERIOR (R) FORD MUSTANG 10-14 FORD MUSTANG 10-14</p>                 | <p><b>CM555</b><br/>HORQUILLA DELANTERO INFERIOR (R) FORD PROBE 93-97 MAZDA 626 93-97 MAZDA MX-6 93-97</p> |



## BAW

|   |   |   |
|---|---|---|
| <p><b>CM1464</b><br/>HORQUILLA DELANTERO INFERIOR (R) FORD RANGER 13-21</p>                                   | <p><b>CM589</b><br/>HORQUILLA DELANTERO INFERIOR (R) FORD TAURUS 86-95 MERCURY SABLE 86-95</p>                | <p><b>CM292</b><br/>HORQUILLA DELANTERO INFERIOR (R) FORD TAURUS 98-07 MERCURY SABLE 98-05</p>                |
| <p><b>CM523</b><br/>HORQUILLA DELANTERO INFERIOR (R) FORD THUNDERBIRD 89-97 LINCOLN MARK VIII 93-98 MERCU</p> | <p><b>CM1557</b><br/>HORQUILLA DELANTERO INFERIOR (R) FORD TRANSIT COURIER 21-22</p>                          | <p><b>CM846</b><br/>HORQUILLA DELANTERO INFERIOR (R) FORD WINDSTAR 95-98</p>                                  |
| <p><b>CM848</b><br/>HORQUILLA DELANTERO INFERIOR (R) FORD WINDSTAR 99-03</p>                                  | <p><b>CM285</b><br/>HORQUILLA DELANTERO INFERIOR FORD FALCON 62-65 FORD MUSTANG 65-66</p>                     | <p><b>CM287</b><br/>HORQUILLA DELANTERO INFERIOR FORD FALCON 68-70 FORD GRANADA 75-80 FORD MAVERICK 70-77</p> |
| <p><b>CM270</b><br/>HORQUILLA DELANTERO INFERIOR FORD FESTIVA 88-93</p>                                       | <p><b>CM548</b><br/>HORQUILLA DELANTERO INFERIOR FORD FUSION 06-07 FORD FUSION 03-07 LINCOLN MKZ 07-07 LI</p> | <p><b>CM284</b><br/>HORQUILLA DELANTERO INFERIOR FORD FUSION 07-12 LINCOLN MKZ 07-12 MERCURY MILAN 07-11</p>  |
| <p><b>CM309</b><br/>HORQUILLA DELANTERO SUPERIOR (L) FORD EXPEDITION 03-04</p>                                | <p><b>CM307</b><br/>HORQUILLA DELANTERO SUPERIOR (L) FORD EXPEDITION 03-06 LINCOLN NAVIGATOR 03-06</p>        | <p><b>CM315</b><br/>HORQUILLA DELANTERO SUPERIOR (L) FORD EXPEDITION 07-17 FORD F150 04-14 FORD FX4 04-08</p> |





## BAW

|  |   |  |
|--|---|--|
| <p><b>CM1117</b><br/>HORQUILLA DELANTERO SUPERIOR (L) FORD EXPEDITION 07-17 FORD F150 09-20 LINCOLN NAVIGA</p> | <p><b>CM1414</b><br/>HORQUILLA DELANTERO SUPERIOR (L) FORD EXPEDITION 18-21 LINCOLN NAVIGATOR 18-21</p>       | <p><b>CM301</b><br/>HORQUILLA DELANTERO SUPERIOR (L) FORD EXPEDITION 97-02 FORD F150 97-03 FORD F250 97-9</p>  |
| <p><b>CM303</b><br/>HORQUILLA DELANTERO SUPERIOR (L) FORD EXPEDITION 97-02 FORD F150 97-03 FORD F250 97-9</p>  | <p><b>CM261</b><br/>HORQUILLA DELANTERO SUPERIOR (L) FORD EXPLORER 02-05 LINCOLN AVIATOR 03-05 MERCURY MO</p> | <p><b>CM265</b><br/>HORQUILLA DELANTERO SUPERIOR (L) FORD EXPLORER 06-10 FORD EXPLORER SPORT TRAC 07-10 M</p>  |
| <p><b>CM255</b><br/>HORQUILLA DELANTERO SUPERIOR (L) FORD EXPLORER 95-01 FORD EXPLORER SPORT 01-03 FORD E</p>  | <p><b>CM940</b><br/>HORQUILLA DELANTERO SUPERIOR (L) FORD F150 SVT RAPTOR 10-14</p>                           | <p><b>CM1131</b><br/>HORQUILLA DELANTERO SUPERIOR (L) FORD FUSION 06-12 LINCOLN MKZ 07-12 LINCOLN ZEPHYR 0</p> |
| <p><b>CM547</b><br/>HORQUILLA DELANTERO SUPERIOR (L) FORD FUSION 06-12 LINCOLN MKZ 07-12 LINCOLN ZEPHYR 0</p>  | <p><b>CM1177</b><br/>HORQUILLA DELANTERO SUPERIOR (L) FORD RANGER 13-21</p>                                   | <p><b>CM257</b><br/>HORQUILLA DELANTERO SUPERIOR (L) FORD RANGER 98-11 MAZDA B2300 01-10 MAZDA B2500 98-0</p>  |
| <p><b>CM299</b><br/>HORQUILLA DELANTERO SUPERIOR (L) FORD THUNDERBIRD 89-97 MERCURY COUGAR 89-97</p>           | <p><b>CM1565</b><br/>HORQUILLA DELANTERO SUPERIOR (L) FORD TRANSIT 15-19</p>                                  | <p><b>CM308</b><br/>HORQUILLA DELANTERO SUPERIOR (R) FORD EXPEDITION 03-04</p>                                 |



## BAW

|   |   |  |
|---|---|--|
| <p><b>CM306</b><br/>HORQUILLA DELANTERO SUPERIOR (R) FORD EXPEDITION 03-06 LINCOLN NAVIGATOR 03-06</p>        | <p><b>CM314</b><br/>HORQUILLA DELANTERO SUPERIOR (R) FORD EXPEDITION 07-17 FORD F150 04-14 FORD FX4 04-08</p> | <p><b>CM1116</b><br/>HORQUILLA DELANTERO SUPERIOR (R) FORD EXPEDITION 07-17 FORD F150 09-20 LINCOLN NAVIGA</p> |
| <p><b>CM1413</b><br/>HORQUILLA DELANTERO SUPERIOR (R) FORD EXPEDITION 18-21 LINCOLN NAVIGATOR 18-21</p>       | <p><b>CM300</b><br/>HORQUILLA DELANTERO SUPERIOR (R) FORD EXPEDITION 97-02 FORD F150 97-03 FORD F250 97-9</p> | <p><b>CM302</b><br/>HORQUILLA DELANTERO SUPERIOR (R) FORD EXPEDITION 97-02 FORD F150 97-03 FORD F250 97-9</p>  |
| <p><b>CM260</b><br/>HORQUILLA DELANTERO SUPERIOR (R) FORD EXPLORER 02-05 LINCOLN AVIATOR 03-05 MERCURY MO</p> | <p><b>CM264</b><br/>HORQUILLA DELANTERO SUPERIOR (R) FORD EXPLORER 06-10 FORD EXPLORER SPORT TRAC 07-10 M</p> | <p><b>CM253</b><br/>HORQUILLA DELANTERO SUPERIOR (R) FORD EXPLORER 95-01 FORD EXPLORER SPORT 01-03 FORD E</p>  |
| <p><b>CM254</b><br/>HORQUILLA DELANTERO SUPERIOR (R) FORD EXPLORER 95-01 FORD EXPLORER SPORT 01-03 FORD E</p> | <p><b>CM939</b><br/>HORQUILLA DELANTERO SUPERIOR (R) FORD F150 SVT RAPTOR 10-14</p>                           | <p><b>CM1130</b><br/>HORQUILLA DELANTERO SUPERIOR (R) FORD FUSION 06-12 LINCOLN MKZ 07-12 LINCOLN ZEPHYR 0</p> |
| <p><b>CM546</b><br/>HORQUILLA DELANTERO SUPERIOR (R) FORD FUSION 06-12 LINCOLN MKZ 07-12 LINCOLN ZEPHYR 0</p> | <p><b>CM1176</b><br/>HORQUILLA DELANTERO SUPERIOR (R) FORD RANGER 13-21</p>                                   | <p><b>CM256</b><br/>HORQUILLA DELANTERO SUPERIOR (R) FORD RANGER 98-11 MAZDA B2300 01-10 MAZDA B2500 98-0</p>  |



## BAW

|  |   |  |
|--|---|--|
| <b>CM298</b><br>HORQUILLA DELANTERO SUPERIOR (R) FORD THUNDERBIRD 89-97 MERCURY COUGAR 89-97 | <b>CM1564</b><br>HORQUILLA DELANTERO SUPERIOR (R) FORD TRANSIT 15-19                  | <b>CM1366</b><br>HORQUILLA INFERIOR TRASERO ERA FORD FOCUS 00-11 VOLVO C30 07-10 VOLVO S40 06-11 VOLVO |
| <b>CM1024</b><br>HORQUILLA TRASERO SUPERIOR FORD EDGE 11-14 LINCOLN MKX 11-15                | <b>CM1058</b><br>HORQUILLA TRASERO SUPERIOR FORD FOCUS 00-18 MAZDA 3 04-13 MAZDA 5 06 | <b>CM1107</b><br>HORQUILLA TRASERO SUPERIOR FORD FUSION 06-12 LINCOLN MKZ 07-12 LINCO                  |
| <b>BA750</b><br>ROTULA DELANTERO SUPERIOR FORD F150 21-21 FORD LOBO 21-21                    | <b>EM119</b><br>SOPORTE MOTOR FORD ECOSPORT 03-12                                     | <b>EM120</b><br>SOPORTE MOTOR FORD ECOSPORT 03-12  |
| <b>EM096</b><br>SOPORTE MOTOR FORD ECOSPORT 13-18  | <b>EM086</b><br>SOPORTE MOTOR FORD ESCAPE 06-13 MERCURY MARINER 06-12                 | <b>EM099</b><br>SOPORTE MOTOR FORD FIESTA 02-10  |
| <b>EM030</b><br>SOPORTE MOTOR FORD FIESTA 02-10 FORD IKON 11-15                              | <b>EM103</b><br>SOPORTE MOTOR FORD FIESTA 11-18                                       | <b>EM050</b><br>SOPORTE MOTOR FORD FIESTA 11-18 FORD FIGO 16-18  |



## BAW

|   |   |  |
|---|---|--|
| <p><b>EM116</b><br/>SOPORTE MOTOR FORD FOCUS 05-11 FORD FOCUS 07-10 MAZDA 3 04-10 MAZDA 5 06-11</p>           | <p><b>EM134</b><br/>SOPORTE MOTOR FRONTAL DER FORD ESCAPE 01-04 FORD ESCAPE 01-06 MAZDA TRIBUTE 01-05 MAZ</p> | <p><b>EM133</b><br/>SOPORTE MOTOR TRASERO FORD COURIER 00-12 FORD FIESTA IKON 98-11 FORD FIESTA 03-12</p>      |
| <p><b>EM029</b><br/>SOPORTE TRANSMISION FORD ECOSPORT 04-12 FORD FIESTA 02-10 FORD IKON 11-15</p>             | <p><b>EM121</b><br/>SOPORTE TRANSMISION FORD ECOSPORT 13-18</p>   | <p><b>EM135</b><br/>SOPORTE TRANSMISION FORD ESCAPE 01-04 FORD ESCAPE 01-06 MAZDA TRIBUTE 01-05 MAZDA TRI</p>  |
| <p><b>EM117</b><br/>SOPORTE TRANSMISION FORD ESCAPE 13-18 FORD EXPLORER 12-15 FORD EXPLORER 16-18 FORD FO</p> | <p><b>EM049</b><br/>SOPORTE TRANSMISION FORD FIESTA 11-18</p>   | <p><b>EM118</b><br/>SOPORTE TRANSMISION FORD KA 01-08</p>  |
| <p><b>TD1332</b><br/>TERMINAL EXTERIOR FORD F250 17-21 FORD F350 17-21</p>                                    | <p><b>TD1355</b><br/>TERMINAL EXTERIOR FORD TRANSIT 20-21</p>   | <p><b>TD1303</b><br/>TERMINAL INTERIOR (L) FORD F250 17-21 FORD F350 17-21 FORD F450 17-21 FORD F550 17-21</p> |
| <p><b>RD875</b><br/>TERMINAL INTERIOR FORD TRANSIT 20-21</p>  | <p><b>SK1144</b><br/>TORNILLO ESTABILIZADOR DELANTERO FORD F150 21-22 FORD LOBO 21-22</p>                     | <p><b>SK1131</b><br/>TORNILLO ESTABILIZADOR DELANTERO FORD RANGER 20-21</p>                                    |



## BAW

|  |  |  |
|--|--|--|
| <p><b>SK1127</b><br/>TORNILLO ESTABILIZADOR TRASERO FORD F250<br/>17-20 FORD F350 17-20 FORD F450 17-20 FORD<br/>F</p> | <p><b>SK1128</b><br/>TORNILLO ESTABILIZADOR TRASERO FORD F250<br/>17-20 FORD F350 17-20 FORD F450 17-20 FORD<br/>F</p> | <p><b>SK1129</b><br/>TORNILLO ESTABILIZADOR TRASERO FORD F250<br/>17-20 FORD F350 17-20 FORD F450 17-20 FORD<br/>F</p> |
| <p><b>SK1130</b><br/>TORNILLO ESTABILIZADOR TRASERO FORD F250<br/>17-20 FORD F350 17-20 FORD F450 17-20 FORD<br/>F</p> |  |  |





## BOBINAS



**KS-548700**

BOBINA ENCENDIDO ELECTRONICO FORD F-150  
F-250 97-99 4.6L



**KS-2002**

BOBINA ENCENDIDO FORD EXCURSION 01  
NAVIGATOR 98-01 PICK UP SERIES F  
97-01 MARQUIS 98-0



**KS-2005**

BOBINA ENCENDIDO FORD FIESTA 98-02  
ECOESPORT FORD KA



**KS-2001**

BOBINA ENCENDIDO FORD RANGER AEROSTAR 6  
CIL 83-97



**KS-2004**

BOBINA ENCENDIDO FORD RANGER MAZDA  
CONTOUR EXPLORER 95-01



**KS-548100**

BOBINA ENCENDIDO FORD WINSTAR EXPLORER  
RANGER

## BOMBAS GASOLINA



**KS-3817A**  
BOMBA GASOLINA CHEVROLET TORNADO  
SILVERADO FORD IKON C/RET T.B.



**KS-2231C/P**  
BOMBA GASOLINA CON PIPETA FORD FUSION



**KS-2220K**  
BOMBA GASOLINA FORD 4.0 EXPLORER



**KS-37**  
BOMBA GASOLINA FORD CROWN VICTORIA



**KS-46K**  
BOMBA GASOLINA FORD F150 F250 PICK UP  
EXPLORER



**KS-2226MK**  
BOMBA GASOLINA FORD FIESTA IKON 00-05  
MONDEO SIN CHECK



**KS-2284MK**  
BOMBA GASOLINA FORD FOCUS WINDSTAR  
ECONOLINE ALTA PRESION C/CHECK



**KS-2157K**  
BOMBA GASOLINA FORD KA 01-05 COUNTUR  
MYSTIQUE



**KS-2157A**  
BOMBA GASOLINA FORD KA 01-05 COUNTUR  
MYSTIQUE 98-00 AZUL



**KS-2157N**  
BOMBA GASOLINA FORD KA 01-05 COUNTUR  
MYSTIQUE 98-00 NEGRA



**KS-2157R**  
BOMBA GASOLINA FORD KA 01-05 COUNTUR  
MYSTIQUE 98-00 ROJA



**KS-2157V**  
BOMBA GASOLINA FORD KA 01-05 COUNTUR  
MYSTIQUE 98-00 VERDE



**KS-06K**  
BOMBA GASOLINA FORD PICK UP 150 250 350  
86-91



**KS-2221K**  
BOMBA GASOLINA FORD PICK UP F150 LINCOLN



**KS-13K**  
BOMBA GASOLINA FORD TOPAZ GHIA 89-94  
GRAND MA

## BOMBAS GASOLINA



**KS-05NKC**  
BOMBA GASOLINA NISSAN TSURU III FLACA GM  
FORD CORTA



**KS-05NK**  
BOMBA GASOLINA NISSAN TSURU III FLACA GM  
FORD LARGA UNIV



**KS-3818**  
BOMBA GASOLINA NISSAN TSURU III FORD T. B.



**TZ-3818**  
BOMBA GASOLINA NISSAN TSURU III FORD T.B.  
TETZUN PREMIUM



**KS-2230K**  
BOMBA GASOLINA SIN RETORNO INFERIOR FORD  
FIESTA



**KS-A235**  
MODULO BOMBA GASOLINA FORD ESCAPE  
MAZDA 2.0L 3.0L 01-04 E2291M



**KS-A219**  
MODULO BOMBA GASOLINA FORD EXPEDITION  
8CIL 5.4L 03-04



**KS-A220**  
MODULO BOMBA GASOLINA FORD EXPLORER  
MERCURY MOUNTAINEER 02-03



**KS-A164**  
MODULO BOMBA GASOLINA FORD EXPLORER  
MOUNTAINEER



**KS-A212**  
MODULO BOMBA GASOLINA FORD EXPLORER  
99-01 MOUNTAINEER 99-01



**KS-A145-MED**  
MODULO BOMBA GASOLINA FORD F150 250 350  
450 10-14 MEDIO MODULO

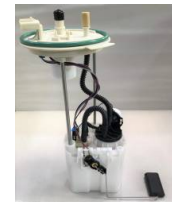

**KS-A278**  
MODULO BOMBA GASOLINA FORD F150 250 350  
450 E150 250 350 10-14



**KS-A223**  
MODULO BOMBA GASOLINA FORD F150 4.2L 4.6L  
5.4L 04-08 E2436M



**KS-A222**  
MODULO BOMBA GASOLINA FORD F150 4.2L 4.6L  
5.4L 05-08 E2434M



**KS-A233**  
MODULO BOMBA GASOLINA FORD MUSTANG 3.8L  
3.9L 4.6L 01-04 E2301M

## BOMBAS GASOLINA



**KS-A157**

MODULO BOMBA GASOLINA FORD SUPER DUTY  
F250 F350 V10 6.8L SUPER DUTY F250 -350 V8  
5.4L



**KS-A145**

MODULO BOMBA GASOLINA FORD SUPER DUTY  
F250 V8 6.2L 15 SUPER DUTY F350 F450 F550 V8  
6.



**KS-041**

MODULO BOMBA GASOLINA FORD V8 PICK UP  
EXPLORER F150 F250 F350 E150 E250 E350  
ECONOLIN



**KS-041-B**

MODULO BOMBA GASOLINA FORD V8 PICK UP  
F150 F250 F350 E150 E250E E350 ECONOLINE



## BUJIAS



### P4TC

BUJIA AUTOMOTRIZ FORD COMERCIALES 85-86  
8V 5.0/5.8LT BL15Y



### QM5RTC-13

BUJIA AUTOMOTRIZ FORD COURIER 01-06  
COURIER 01-06FIESTA IKON 01-04FORD KA  
01-04FIESTA



### 7989

BUJIA AUTOMOTRIZ FORD EXPEDITION 05-08  
EXPEDITION 05-08EXPLORER SPORT TRAC  
07-08F-250



### T4TC

BUJIA AUTOMOTRIZ FORD F350 86-93 F350  
86-93F250 92-96F150 80-86GRAND MARQUIS  
82-84MAV



### QH7RTC-11

BUJIA AUTOMOTRIZ FORD VAN E-150 04-06 FORD  
VAN E-150 04-06F-150 05-09



## BUJIAS DENSO



**PT20TT**  
BUJIA FORD ECOSPORT L4-2.0L 13-17



**ITV20**  
BUJIA FORD F150 L6-3.5L 09-20



**PTV16TT**  
BUJIA FORD FIGO L4-1.5L 16-18













**T16VR-U10**  
BUJIA FORD FIGO L4-1.5L 16-18

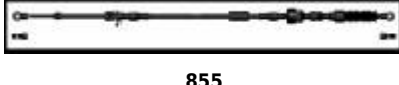
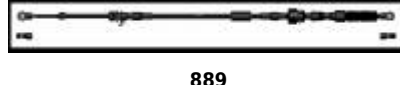
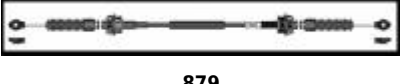

**T20EPR-U15**  
BUJIA FORD RANGER L4.-2.3 05-12

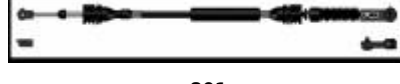
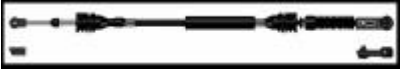

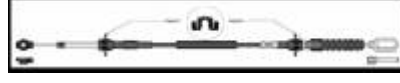
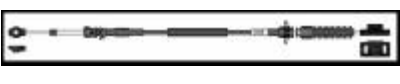











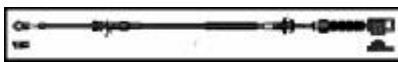

## CATRASA

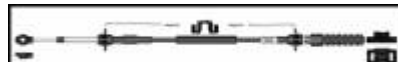
|  |   |  |
|--|---|--|
|  <p><b>839</b><br/>LIBERADOR PALANCA VELOCIDADES FORD AUT</p>                     |  <p><b>839A</b><br/>LIBERADOR PALANCA VELOCIDADES FORD AUT</p>                     |  <p><b>850</b><br/>SECTOR VELOCIDADES CHICOTE FORD AEROSTAR U.S.A.(CORTO) AUT</p>         |
|  <p><b>851</b><br/>SECTOR VELOCIDADES CHICOTE FORD AEROSTAR U.S.A.(LARGO) AUT</p> |  <p><b>855</b><br/>SECTOR VELOCIDADES CHICOTE FORD AEROSTAR USA 6CIL 93-97 AUT</p> |  <p><b>889</b><br/>SECTOR VELOCIDADES CHICOTE FORD CAMION DOBLE RODADO MOT 5.3 98 AUT</p> |
|  <p><b>879</b><br/>SECTOR VELOCIDADES CHICOTE FORD CONTOUR 04 AUT</p>             |  <p><b>891</b><br/>SECTOR VELOCIDADES CHICOTE FORD CONTOUR 6 CIL 98 STD</p>        |  <p><b>801</b><br/>SECTOR VELOCIDADES CHICOTE FORD COUGAR (MONDEO 04) 00- STD</p>         |
|  <p><b>802</b><br/>SECTOR VELOCIDADES CHICOTE FORD COUGAR (MONDEO 04) 00- STD</p> |  <p><b>803</b><br/>SECTOR VELOCIDADES CHICOTE FORD COUGAR 6 CIL 00- STD</p>        |  <p><b>868</b><br/>SECTOR VELOCIDADES CHICOTE FORD CROWN VICTORIA 95 AUT</p>              |
|  <p><b>806</b><br/>SECTOR VELOCIDADES CHICOTE FORD ECONOLINE 05 AUT</p>         |  <p><b>876</b><br/>SECTOR VELOCIDADES CHICOTE FORD ECONOLINE 96 AUT</p>          |  <p><b>869</b><br/>SECTOR VELOCIDADES CHICOTE FORD ECONOLINE 98 AUT</p>                 |

















## CATRASA

|  |   |   |
|--|---|---|
|  <p><b>871</b><br/>SELECTOR VELOCIDADES CHICOTE FORD<br/>ECONOLINE 98 AUT</p>                 |  <p><b>817</b><br/>SELECTOR VELOCIDADES CHICOTE FORD<br/>ECONOLINE SERIE 350 XLT 04- AUT</p> |  <p><b>816</b><br/>SELECTOR VELOCIDADES CHICOTE FORD ESCAPE<br/>MOT 2.0 4CIL MAZDA 03- AUT</p> |
|  <p><b>815</b><br/>SELECTOR VELOCIDADES CHICOTE FORD ESCAPE<br/>MOT 2.0 4CIL MAZDA 06 STD</p> |  <p><b>804</b><br/>SELECTOR VELOCIDADES CHICOTE FORD<br/>EXPEDITION 00- AUT</p>              |  <p><b>881</b><br/>SELECTOR VELOCIDADES CHICOTE FORD<br/>EXPEDITION 04-06 AUT</p>              |
|  <p><b>884</b><br/>SELECTOR VELOCIDADES CHICOTE FORD<br/>EXPEDITION 96 AUT</p>                |  <p><b>862</b><br/>SELECTOR VELOCIDADES CHICOTE FORD<br/>EXPEDITION SUPER DUTY 99-00 AUT</p> |  <p><b>890</b><br/>SELECTOR VELOCIDADES CHICOTE FORD<br/>EXPLORER 02 04 AUT</p>                |
|  <p><b>818</b><br/>SELECTOR VELOCIDADES CHICOTE FORD<br/>EXPLORER 04- AUT</p>                 |  <p><b>814</b><br/>SELECTOR VELOCIDADES CHICOTE FORD<br/>EXPLORER 06 AUT</p>                 |  <p><b>866</b><br/>SELECTOR VELOCIDADES CHICOTE FORD<br/>EXPLORER 97 AUT</p>                   |
|  <p><b>861</b><br/>SELECTOR VELOCIDADES CHICOTE FORD<br/>EXPLORER RANGER 89-91 AUT</p>      |  <p><b>860</b><br/>SELECTOR VELOCIDADES CHICOTE FORD<br/>EXPLORER RANGER 93 AUT</p>        |  <p><b>874</b><br/>SELECTOR VELOCIDADES CHICOTE FORD<br/>EXPLORER RANGER 97-01 AUT</p>       |

















## CATRASA

|   |   |   |
|---|---|---|
|  <p><b>854</b><br/>SELECTOR VELOCIDADES CHICOTE FORD EXPLORER USA RANGER 3.0 97-02 AUT</p> |  <p><b>898</b><br/>SELECTOR VELOCIDADES CHICOTE FORD FIESTA ECOSPORT EXPEDIT 03-05 STD</p> |  <p><b>896</b><br/>SELECTOR VELOCIDADES CHICOTE FORD FOCUS 03- STD</p>         |
|  <p><b>887</b><br/>SELECTOR VELOCIDADES CHICOTE FORD FOCUS MOT 2.0 ZETEC 00 STD</p>        |  <p><b>807</b><br/>SELECTOR VELOCIDADES CHICOTE FORD FOCUS TAURUS FIESTA 01 AUT</p>        |  <p><b>885</b><br/>SELECTOR VELOCIDADES CHICOTE FORD FOCUS ZX3 01-05 STD</p>   |
|  <p><b>895</b><br/>SELECTOR VELOCIDADES CHICOTE FORD FREESTAR 01 AUT</p>                   |  <p><b>805</b><br/>SELECTOR VELOCIDADES CHICOTE FORD FUSION 01-06 AUT</p>                  |  <p><b>877</b><br/>SELECTOR VELOCIDADES CHICOTE FORD GRAN MARQUIS 92 AUT</p>   |
|  <p><b>864</b><br/>SELECTOR VELOCIDADES CHICOTE FORD GRAN MARQUIS 92 LINCOLN 96 AUT</p>    |  <p><b>811</b><br/>SELECTOR VELOCIDADES CHICOTE FORD GRAN MARQUIS 92-95 AUT</p>            |  <p><b>870</b><br/>SELECTOR VELOCIDADES CHICOTE FORD GRAND MARQUIS 92 AUT</p>  |
|  <p><b>893</b><br/>SELECTOR VELOCIDADES CHICOTE FORD LOBO 09-11 AUT</p>                  |  <p><b>858</b><br/>SELECTOR VELOCIDADES CHICOTE FORD LOBO EXPEDITION F250 95-98 AUT</p>  |  <p><b>859</b><br/>SELECTOR VELOCIDADES CHICOTE FORD LOBO F250 97-98 AUT</p> |

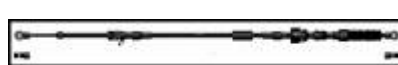













## CATRASA

|   |  |  |
|---|--|--|
|  <p><b>894</b><br/>SELECTOR VELOCIDADES CHICOTE FORD LOBO<br/>MOT 5.4 4.6 04 AUT</p>         |  <p><b>882</b><br/>SELECTOR VELOCIDADES CHICOTE FORD LOBO<br/>MOTOR 5.4 4.6 05 AUT</p>          |  <p><b>872</b><br/>SELECTOR VELOCIDADES CHICOTE FORD LOBO<br/>TRITON F250 04- AUT</p>           |
|  <p><b>878</b><br/>SELECTOR VELOCIDADES CHICOTE FORD<br/>MERCURY MINI VAN LOBO 96-98 AUT</p> |  <p><b>808</b><br/>SELECTOR VELOCIDADES CHICOTE FORD<br/>MERCURY SABLE MUSTANG 6CIL 00- AUT</p> |  <p><b>812</b><br/>SELECTOR VELOCIDADES CHICOTE FORD<br/>MONDEO MOT 2.5 03 STD</p>              |
|  <p><b>810</b><br/>SELECTOR VELOCIDADES CHICOTE FORD<br/>MONDEO MOT 2.5 04 STD</p>           |  <p><b>875</b><br/>SELECTOR VELOCIDADES CHICOTE FORD<br/>MUSTANG MOTOR 4.6 99 AUT</p>           |  <p><b>853</b><br/>SELECTOR VELOCIDADES CHICOTE FORD PICK UP<br/>F150 6CIL F250 8CIL 95 AUT</p> |
|  <p><b>880</b><br/>SELECTOR VELOCIDADES CHICOTE FORD PICK UP<br/>F150 AUT</p>                |  <p><b>883</b><br/>SELECTOR VELOCIDADES CHICOTE FORD PICK UP<br/>F150 ECONOLINE 95-98 AUT</p>   |  <p><b>857</b><br/>SELECTOR VELOCIDADES CHICOTE FORD PICK UP<br/>F250 RANGER 92-96 AUT</p>      |
|  <p><b>809</b><br/>SELECTOR VELOCIDADES CHICOTE FORD PICK UP<br/>F350 DIESEL 96-98 AUT</p> |  <p><b>873</b><br/>SELECTOR VELOCIDADES CHICOTE FORD TAURUS<br/>86 AUT</p>                    |  <p><b>852</b><br/>SELECTOR VELOCIDADES CHICOTE FORD TAURUS<br/>90-96 AUT</p>                 |









## CATRASA

|  |   |  |
|--|---|--|
|  <p><b>865</b><br/>SELECTOR VELOCIDADES CHICOTE FORD TAURUS 92 AUT</p>                |  <p><b>867</b><br/>SELECTOR VELOCIDADES CHICOTE FORD TAURUS SABLE GIA 96 AUT</p>     |  <p><b>843</b><br/>SELECTOR VELOCIDADES CHICOTE FORD TOPAZ (TEMPO) 85-92 STD</p>      |
|  <p><b>843A</b><br/>SELECTOR VELOCIDADES CHICOTE FORD TOPAZ CON AJUSTES 85-92 STD</p> |  <p><b>863</b><br/>SELECTOR VELOCIDADES CHICOTE FORD WINDSTAR 6 CIL 95-98 03 AUT</p> |  <p><b>856</b><br/>SELECTOR VELOCIDADES CHICOTE FORD WINDSTAR ECONOLINE 92-96 AUT</p> |
|  <p><b>834</b><br/>SELECTOR VELOCIDADES FORD ESCAPE MOT 3.0 AUT 08</p>                |  <p><b>835</b><br/>SELECTOR VELOCIDADES FORD F150 AUT 14</p>                         | <p><b>830</b><br/>SELECTOR VELOCIDADES FORD FIGO AUT 17</p>  |
|  <p><b>828</b><br/>SELECTOR VELOCIDADES FORD FIGO FIESTA 11 STANDARD 17</p>         |  <p><b>831</b><br/>SELECTOR VELOCIDADES FORD FOCUS AUT 13</p>                      | <p><b>836</b><br/>SELECTOR VELOCIDADES FORD FUSSION AUT 08</p>   |
|  <p><b>892</b><br/>TRANSVERSAL VELOCIDADES FORD CONTOUR 6 CIL 98 STD</p>            |  <p><b>800</b><br/>TRANSVERSAL VELOCIDADES FORD FIESTA 02 STD</p>                  |  <p><b>899</b><br/>TRANSVERSAL VELOCIDADES FORD FIESTA ECOSPORT EXPED 03-05 STD</p> |



## CATRASA

|   |  |  |
|---|--|--|
|  <p><b>829</b><br/>TRANSVERSAL VELOCIDADES FORD FIGO FIESTA<br/>11 STANDARD 17</p> |  <p><b>886</b><br/>TRANSVERSAL VELOCIDADES FORD FOCUS 01-05<br/>STD</p>       |  <p><b>897</b><br/>TRANSVERSAL VELOCIDADES FORD FOCUS 03<br/>STD</p>    |
|  <p><b>888</b><br/>TRANSVERSAL VELOCIDADES FORD FOCUS MOT<br/>2.0 00 STD</p>       |  <p><b>813</b><br/>TRANSVERSAL VELOCIDADES FORD MONDEO<br/>MOT 2.5 03 STD</p> |  <p><b>844</b><br/>TRANSVERSAL VELOCIDADES FORD TOPAZ 85-92<br/>STD</p> |

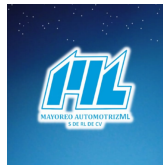

## CEDAZOS

|   |  |   |
|---|--|---|
|  <p style="text-align: center;"><b>ST/85</b><br/>CEDAZO BOMBA GASOLINA KS-06K FORD PICK UP 150 250 350 86-91 CUTLASS CIERA 2.5L L4 BBL</p> |  <p style="text-align: center;"><b>ST/283</b><br/>CEDAZO BOMBA GASOLINA KS-2220K FORD 4.0 EXPLORER FORD TAURUSSABLE 3.0L V6 98-00 PICKU</p> |  <p style="text-align: center;"><b>ST/2226AK</b><br/>CEDAZO BOMBA GASOLINA KS-2226MK FORD FOCUS WINDSTAR ECONOLINE FORD FIESTA 1.3L 1.4L L</p> |
|  <p style="text-align: center;"><b>ST/205</b><br/>CEDAZO BOMBA GASOLINA KS-2284MK FORD FOCUS WINDSTAR ECONOLINE</p>                        |  <p style="text-align: center;"><b>ST/32</b><br/>CEDAZO BOMBA GASOLINA KS-46K FORD BRONCO 4.9L L6 OHV 90-93 BRONCO 5.0L V8 OHV 90-96 B</p>  |  <p style="text-align: center;"><b>ST/10</b><br/>CEDAZO FORD FOCUS ESCAPE FUSION</p>   |
|  <p style="text-align: center;"><b>ST/09</b><br/>CEDAZO FORD PICK UP LOBO EXPLORER</p>   |  <p style="text-align: center;"><b>ST/06</b><br/>CEDAZO FORD TSURU III CONTOUR MYSTIQUE ST06</p>  |  <p style="text-align: center;"><b>C-39/FK</b><br/>CEDAZO FORD WINDSTAR COUGAR SABLE TAURUS TERMINACION FK</p>                               |
|  <p style="text-align: center;"><b>ST/05</b><br/>CEDAZO MITSUBISHI TOYOTA FORD MAZDA JEEP</p>  |  <p style="text-align: center;"><b>ST/31</b><br/>CEDAZO RETORNO FORD FUSION</p>   |   |



## COLLARIN HIDRAULICO



**510001111**

COLLARIN HIDRAULICO FORD FIESTA 99-08 KA  
90-96 ECOSPORT 99-06



**CHB-006**

COLLARIN HIDRAULICO FORD FIESTA T/LUK



**CHB-003**

COLLARIN HIDRAULICO FORD LOBO BSK



**CHB-004**

COLLARIN HIDRAULICO FORD RANGER EXPLORER  
ALUMINIO



**CHB-005**

COLLARIN HIDRAULICO FORD RANGER EXPLORER  
PLASTICO

## ENCENDIDO



**CB-330**

CABLES BUJIAS FORD FIESTA IKON KA 1.6L 01-07



**CB-263**

CABLES BUJIAS FORD RANGER 2.3L 01-12  
SILICON KEM CB-263

## ENFRIAMIENTO



**BA-FIESTA-200**  
BOMBA AGUA FORD FIESTA 1.6



**CODO**  
CODO TOMA AGUA ESCORPIO FORD FIESTA



**DP-FRD-100**  
DEPOSITO ANTICONGELANTE FORD FIESTA 1.6L  
03-08 2SAL ECOSPOR



**356Q8575A2A**  
TERMOSTATO BOMBA AGUA FORD FIESTA ORIG  
FRANC



**XW-FIESTA-AL**  
TOMA AGUA ESCORPION Y RECTA ALUMINIO  
FORD FIESTA



**XW-FIESTA**  
TOMA AGUA ESCORPION Y RECTA PLASTICA  
FORD FIESTA



**KS7294 C/G**  
TOMA AGUA FORD EXPLORER 4.0 C/G C/S KS  
(CON BULBO Y TER)



**KS7294 C/R**  
TOMA AGUA FORD EXPLORER 4.0 C/R C/S



**KS7294**  
TOMA AGUA FORD EXPLORER 4.0 C/R KS (SIN  
BULBO)



**6X5-4G9K-47880**  
TOMA AGUA FORD FOCUS





## FILTROS ACEITE



**CH8814**  
CARTUCHO ACEITE FORD MONDEO



**CH7508**  
CARTUCHO ACEITE FORD RANGER 04-11



**CH9641**  
CARTUCHO ACEITE MAZDA 5 07-10 MAZDA 6  
03-11 FORD ESCAPE 06-



**3600**  
FILTRO ACEITE AUTOS FORD 4/6 CIL = GP3600

**FAC-3600**  
FILTRO ACEITE AUTOS FORD 4/6 CIL = GP3600

**FAC-3614**  
FILTRO ACEITE FORD FIESTA RANGER TOYOTA  
TACOMA HIACE



**3614**  
FILTRO ACEITE FORD FIGO 1.5 16-17 FIESTA SDN  
1.6 05-16

**FAC-2**  
FILTRO ACEITE FORD MARQUIS LOBO GP = 68

**002**  
FILTRO ACEITE FORD MARQUIS LOBO GP = 68



**FAC-8**  
FILTRO ACEITE FORD PICK UP F150 = GP1

**PH-8**  
FILTRO ACEITE FORD PICK UP F150 = GP1

**PH-43**  
FILTRO ACEITE FORD PICKUP CORTO GP-9





## FILTROS AIRE



**AF-6366**

FILTRO AIRE CAMIONETA FORD F-350 BRONCO



**AF-3878**

FILTRO AIRE FORD ECOSPORT 03-05 4CIL



**AF-7774**

FILTRO AIRE FORD EXPLORER F100 RANGER  
(CAJA 33 PZAS)



**CA-12183**

FILTRO AIRE FORD F250 F350 F450 F550 SD  
17-19



**AF-5729**

FILTRO AIRE FORD FIESTA 00-02 LARGO



**FA-1904**

FILTRO AIRE FORD FIESTA 10-14 DIAGONAL



**AF-580**

FILTRO AIRE FORD FIESTA 98-99 CORTO



**CA-10997**

FILTRO AIRE FORD FIGO 16-17, ECOSPORT 13-17,  
10-16

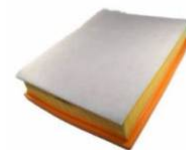

**CA-11480**

FILTRO AIRE FORD FUSION 13-18 EDGE 15-18



**AF-8925**

FILTRO AIRE FORD LOBO EXPEDITION 04-05

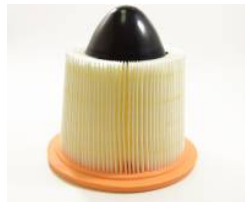

**AF-8039**

FILTRO AIRE FORD LOBO EXPEDITION BALA  
GRANDE (CAJA 26 PZAS)

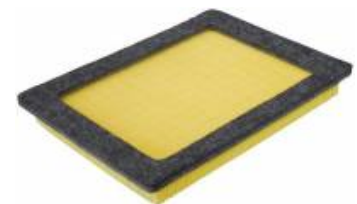

**AF-9687**

FILTRO AIRE FORD LOBO PANEL



**AF-583**

FILTRO AIRE FORD MONDEO 2.0 2.5LT



**AF-1277**

FILTRO AIRE FORD MUSTANG 05



**AF-5057**

FILTRO AIRE FORD MUSTANG V8 TAURUS  
COUGAR



## FILTROS AIRE



**AF-381**  
FILTRO AIRE FORD PICK UP FARIMONT



**FA-3596**  
FILTRO AIRE FORD RANGER 13-14



**AF-5058**  
FILTRO AIRE FORD TAURUS 90-93 WINDSTAR



**AF-7171**  
FILTRO AIRE FORD TRANSIT 12-13

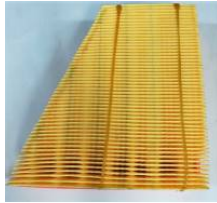

**FA-7N15**  
FILTRO AIRE VW GOL 1.6L SAVEIRO 08-10 FORD  
ECOSPORT AUT 07



## FILTROS GASOLINA



**FG-189-E**

FILTRO GASOLINA ECOLOG FORD EXPLORER RAM



**FG-18**

FILTRO GASOLINA FORD AEROSTAR ESCAPE  
EXPEDITION EXPLORER LOBO



**FG-11**

FILTRO GASOLINA FORD AEROSTAR TOPAZ  
MUSTANG SEDA WAGON



**FG-21**

FILTRO GASOLINA FORD COUGAR XR7  
THUNDERBIRD MARK VIII



**FG-132**

FILTRO GASOLINA FORD COURIER L/XL 98-00  
01-02



**FG-10**

FILTRO GASOLINA FORD ESCORT



**FG-133**

FILTRO GASOLINA FORD EXCURSION EXPEDITION  
EXPLORER FIESTA SEDAN



**FG-238**

FILTRO GASOLINA FORD LOBO 05-07 EXPLORER  
03-09 F150 250 350 450



**FG-203**

FILTRO GASOLINA FORD RANGER 01-06 ( 2.3 3.0  
4.0)



**FG-207**

FILTRO GASOLINA FORD RANGER EXPL EXPEDI  
NAVI V4 V6 V



**F-145**

FILTRO MODULO FORD SUPER DUTY F350 F450  
F550 11-14

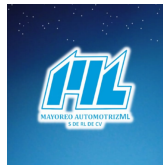

## FILTROS UNIFIL

|  |  |   |
|--|--|---|
|  <p><b>FO-11955</b><br/>FILTRO ACEITE CARTUCHO FORD EDGE 2.7L<br/>EXPLORER ST 3.0L 20-</p>            |  <p><b>FO-10575</b><br/>FILTRO ACEITE CARTUCHO FORD EQUINOX<br/>FUSION LIBERTY 08-12</p>                      |  <p><b>FO-2</b><br/>FILTRO ACEITE CARTUCHO FORD ESCAPE LOBO<br/>G.CHEROKEE 09-15</p>                                   |
|  <p><b>FO-9549</b><br/>FILTRO ACEITE CARTUCHO FORD F-250 350 450<br/>550 6.0 6.4L V8 DIESEL 03-10</p> |  <p><b>FO-10890</b><br/>FILTRO ACEITE CARTUCHO FORD F-250 350<br/>SUPER DUTY V8 6.7L DIESEL F-450 550 11-</p> |  <p><b>FO-9954</b><br/>FILTRO ACEITE CARTUCHO FORD FOCUS 2.5L<br/>VOLVO C30 08-13</p>                                  |
|  <p><b>FO-9641</b><br/>FILTRO ACEITE CARTUCHO FORD MAZDA 3<br/>FUSION 2.3L MAZDA 5 07-10</p>         |  <p><b>FO-11651</b><br/>FILTRO ACEITE CARTUCHO FORD RANGER DIESEL<br/>2.2 3.2L TDCI 11-18</p>                |  <p><b>FO-10060</b><br/>FILTRO ACEITE CARTUCHO PEUGEOT 206 207 1.4<br/>1.6L 208 13-15 308 09-11 MANAGER 09-16 FOR</p> |
|  <p><b>FO-16</b><br/>FILTRO ACEITE CARTUCHO UNIVERSAL<br/>UNIVERSAL FORD CHRYSLER DODGE</p>         |  <p><b>FO-3600</b><br/>FILTRO ACEITE CARTUCHO UNIVERSAL<br/>UNIVERSAL FORD CHRYSLER DODGE</p>               |  <p><b>FO-3614</b><br/>FILTRO ACEITE CARTUCHO UNIVERSAL<br/>UNIVERSAL FORD FIGO 16- GM CHRYSLER<br/>TOYOTA</p>       |
|  <p><b>FO-8316</b><br/>FILTRO ACEITE FORD FOCUS ESCAPE 2.0L KA<br/>1.6L 00-08</p>                   |  <p><b>FO-85TK</b><br/>FILTRO ACEITE SINTETICO CHRYSLER DODGE<br/>FORD NISSAN TOYOTA AUTOS Y CAMINETAS</p>  |  <p><b>FO-165TK</b><br/>FILTRO ACEITE SINTETICO FORD CHRYSLER<br/>DODGE</p>  |



## FILTROS UNIFIL



**FO-3600STK**  
FILTRO ACEITE SINTETICO FORD CHRYSLER  
DODGE



**FO-3614STK**  
FILTRO ACEITE SINTETICO FORD FIGO 16-  
CHEVROLET CHRYSLER TOYOTA



**FO-25TK**  
FILTRO ACEITE SINTETICO FORD G.CHEROKEE  
09-15 ESCAPE LOBO 01-08



**FO-10575STK**  
FILTRO ACEITE SINTETICO FORD LIBERTY 08-12  
EQUINOX FUSION 11-15

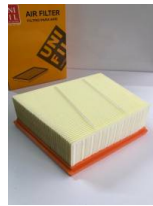

**FA-11864**  
FILTRO AIRE FORD ECOSPORT 2.0L



**FA-9833**  
FILTRO AIRE FORD ECOSPORT 2.0L



**FA-10293**  
FILTRO AIRE FORD ECOSPORT 2.0L AUTO.

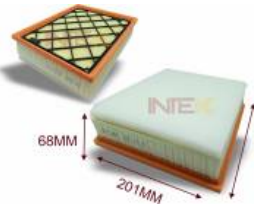

**FA-11480**  
FILTRO AIRE FORD EDGE 2.0 2.7 3.5L FUSION 13-



**FA-12260**  
FILTRO AIRE FORD EQUINOX TERRAIN 1.5 1.6  
2.0L TURBO

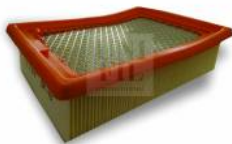

**FA-11456N**  
FILTRO AIRE FORD ESCAPE 2.5L TRANSIT  
CONNECT 13-16

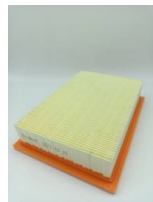

**FA-8997**  
FILTRO AIRE FORD ESCAPE L4 2.3L 2.0L 01-04



**FA-10616N**  
FILTRO AIRE FORD ESCAPE V6 3.0L MAZDA  
TRIBUTE MERCURY MARINER 09-11

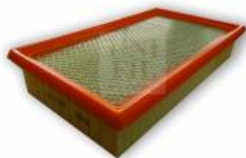

**FA-9332N**  
FILTRO AIRE FORD EXPLORER 4.0L

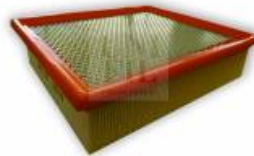

**FA-10262**  
FILTRO AIRE FORD F-150 3.0 3.3L V6 V6 3.5L  
(EXPEDITION 3.5L 15- 5.4L 07-17 F-150 2.7L



**FA-8039**  
FILTRO AIRE FORD F-150 350 4.2 4.6L LOBO 4.6L  
E-150 350 4.6 5.4 6.8L





## FILTROS UNIFIL



**FA-9687**

FILTRO AIRE FORD F-150 350 5.4L LOBO 5.4L  
EXPEDITION 4.6L



**FA-10270**

FILTRO AIRE FORD F-250 350 6.4L V8 DIESEL  
TURBO F-450 550



**FA-10888**

FILTRO AIRE FORD F-250 350 6.7L V8 DIESEL  
TURBO F-450 550 650 750 FA-1902



**FA-12183**

FILTRO AIRE FORD F-250 350 GASOLINA V8 6.2L  
SUPER DUTY F-450 550 V10 6.8L 17-20 FA-19



**FA-12182**

FILTRO AIRE FORD F-250 DIESEL V8 6.7L SUPER  
DUTY F-350 450 550 FA-1927 C ESPUMA

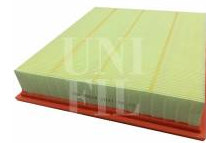

**FA-99534**

FILTRO AIRE FORD F-250 GASOLINA V8 6.2 7.3L  
SUPER DUTY PICK UP F-350 F450 F-550



**FA-99532**

FILTRO AIRE FORD F-250 TURBO DIESEL V8 6.7L  
SUPER DUTY PICK UP F-350 F450 F-550 C FEL



**FA-9494**

FILTRO AIRE FORD FIESTA 1.6L MINI COOPER  
04-10



**FA-10997**

FILTRO AIRE FORD FIESTA 1.6L TRAPECIO FIGO  
1.5L 16-18



**FA-9511N**

FILTRO AIRE FORD FIESTA FIRST 1.6L RECT

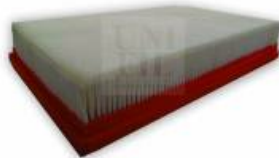

**FA-580N**

FILTRO AIRE FORD FIESTA IKON 1.6L C ESPONJA  
COURIER 00-12

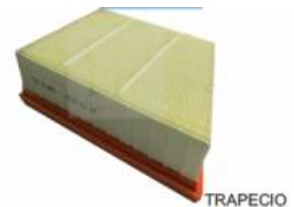

**FA-12369**

FILTRO AIRE FORD FIGO 1.5L TRAPECIO  
ECOSPORT 1.5 2.0L 19-



**FA-11114**

FILTRO AIRE FORD FOCUS CILINDRICO 2.0L  
ESCAPE 2.0L 13-19



**FA-8956**

FILTRO AIRE FORD FREESTAR 3.9 4.2L  
THUNDERBIRD 02-05



**FA-11482**

FILTRO AIRE FORD FUSION 2.0L TURBO C-MAX  
13-18



## FILTROS UNIFIL



**FA-10094**  
FILTRO AIRE FORD FUSION MILAN 2.3L 2.5L  
10-12

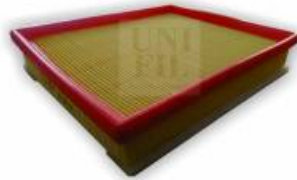

**FA-8736**  
FILTRO AIRE FORD KA 1.6L

**FA-583N**  
FILTRO AIRE FORD MONDEO 2.0/2.5L (3.0L 04-05)  
01-07



**FA-10781**  
FILTRO AIRE FORD MUSTANG 3.7L V6 (4.6L V8  
2010 5.0L V8 11-14)



**FA-74N**  
FILTRO AIRE FORD MUSTANG 3.8L 5.0L 73-81

**FA-11674**  
FILTRO AIRE FORD RANGER 2.2 3.2L DIESEL 2.5L  
GASOLINA ARGENTINO



**FA-8243**  
FILTRO AIRE FORD RANGER 2.3L 2.5L 98-01



**FA-1931**  
FILTRO AIRE FORD SECUNDARIO 2.2L DIESEL  
TURBO 14-

**FA-11946**  
FILTRO AIRE FORD TRANSIT 150 250 350 350HD  
3.2 3.5L DIESEL TURBO

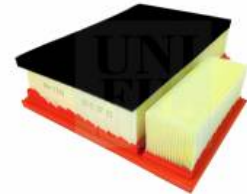

**FA-11488**  
FILTRO AIRE FORD TRANSIT 2.2L DIESEL TURBO

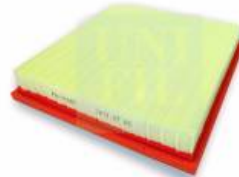

**FA-10290**  
FILTRO AIRE FORD TRANSIT 2.2L DIESEL TURBO  
COLORADO V63.6L 15-17

**FA-8919**  
FILTRO AIRE FORD TRANSIT DIESEL 2.2L TDCI  
NISSAN FRONTIER DIESEL 2.5L YD25 15-

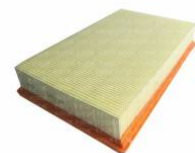

**FA-10071**  
FILTRO AIRE FORD V10 6.8L SUPER DUTY (F53  
6.8L 05-19 F59 6.8L 11-19 F53/F59 V8 7.3L 2

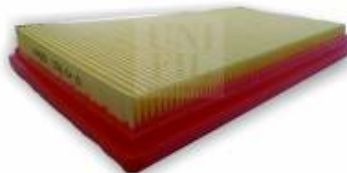

**FA-5058**  
FILTRO AIRE FORD WINDSTAR 3.0L

**FA-7774**  
FILTRO AIRE FORD WINDSTAR 3.8L EXPLORER  
4.0L 95-97







## FILTROS UNIFIL



**FC-11743**

FILTRO CABINA FORD 150 250 350 350 HD 2.2L DIESEL



**FC-99542**

FILTRO CABINA FORD BRONCO SPORT 1.5/2.0L (ESCAPE 1.5/2.0/2.5L 20- EXPLORER 2.3/3.0/3.0)



**FC-12150**

FILTRO CABINA FORD F150 2.7 3.5 5.0L EXPEDITION 3.5L 18- F150 3.0 3.3L 18- F250 F350



**FD-11507**

FILTRO DIESEL CARTUCHO FORD RANGER 2.2 3.2L TDCi



**FD-10458**

FILTRO DIESEL FORD F-250 350 SUPER DUTY 6.7L V8 DIESEL KIT 2 PZAS F-450 550 FD-4625



**FD-339**

FILTRO DIESEL FORD F-250 SUPER DUTY 6.7L V8 DIESEL KIT 2 PZAS F-350 450 550 650 750



**FD-4626**

FILTRO DIESEL FORD F-650 750 SUPER DUTY 6.7L V8 DIESEL KIT 2 PZAS FD-4626



**FD-4626K**

FILTRO DIESEL FORD F-650/750 SUPER DUTY 6.7L V8 DIESEL KIT/2 PZAS (FD-4626)



**FD-8158**

FILTRO DIESEL FORD TRANSIT SEPARADOR DE AGUA 2.2 2.4 3.2L TDCi

**FG-11-U**

FILTRO GAS FORD COUNTOUR ESCAPE RANGER 01-08

**FG-348-U**

FILTRO GAS FORD RANGER 2.5L 15-

**FG-133-U**

FILTRO GASOLINA FORD EXCURSION EXPEDITION EXPLORER FIESTA SEDAN



**FG-5024**

FILTRO GASOLINA FORD FIGO 1.5L 15- UNIFIL



## FRENOS



**BMC-FD390696**

BOMBA FRENO FORD RANGER 06-11, MAZDA B2300 01-09, B4000 03-04, MOUNTAINEER 98-07



**BRR0200-P**

CILINDRO RUEDA FRENOS TRASERA FORD FIESTA IKON 01-03



**WC-FD3700904P**

CILINDRO RUEDA FRENOS TRASERO DER-IZQ FORD COURIER 7-8 01-06



**KTFR-323L**

KIT FRENOS (L) ESTACIONAMIENTO FORD LOBO



**KTFR-309L**

KIT FRENOS (L) FORD AEROSTAR 87-94 RANGER 83-94 EXPLORER



**KTFR-332L**

KIT FRENOS (L) FORD ECO SPORT FIESTA



**KTFR-320L**

KIT FRENOS (L) FORD ESCAPE 01-04



**KTFR-337L**

KIT FRENOS (L) FORD ESCAPE 08-10 MARINER 07-10



**KTFR-302L**

KIT FRENOS (L) FORD F-150 76-86 ECONOLINE



**KTFR-304**

KIT FRENOS (L) FORD F-250 F-350 68-98 MICROBUS 86



**KTFR-300L**

KIT FRENOS (L) FORD GALAXIE 70-72 LTD 79-82 MARQUIS



**KTFR-308L**

KIT FRENOS (L) FORD LOBO 99-00 F-150



**KTFR-319L**

KIT FRENOS (L) FORD MARQUIS EXPLORER 95-



**KTFR-313L**















KIT FRENOS (L) FORD RANGER 95-02



**KTFR-322L**

KIT FRENOS (L) FORD RANGER 95-02

## FRENOS

|  |  |   |
|--|--|---|
|  <p><b>KTFR-310L</b><br/>KIT FRENOS (L) FORD WINDSTAR 93-95 NISSAN QUEST 93-01</p>    |  <p><b>KTFR-315L</b><br/>KIT FRENOS (L) FORD WINDSTAR 95-01</p>         |  <p><b>KTFR-323R</b><br/>KIT FRENOS (R) ESTACIONAMIENTO FORD LOBO</p>                |
|  <p><b>KTFR-309R</b><br/>KIT FRENOS (R) FORD AEROSTAR 87-94 RANGER 83-94 EXPLORER</p> |  <p><b>KTFR-332R</b><br/>KIT FRENOS (R) FORD ECO SPORT FIESTA</p>       |  <p><b>KTFR-320R</b><br/>KIT FRENOS (R) FORD ESCAPE 01-04</p>                        |
|  <p><b>KTFR-337R</b><br/>KIT FRENOS (R) FORD ESCAPE 08-10 MARINER 07-10</p>          |  <p><b>KTFR-302R</b><br/>KIT FRENOS (R) FORD F-150 76-86 ECONOLINE</p> |  <p><b>KTFR-303</b><br/>KIT FRENOS (R) FORD F-250 F-350 68-98 MICROBUS 86</p>       |
|  <p><b>KTFR-300R</b><br/>KIT FRENOS (R) FORD GALAXIE 70-72 LTD 79-82 MARQUIS</p>    |  <p><b>KTFR-308</b><br/>KIT FRENOS (R) FORD LOBO 99-00 F-150</p>      |  <p><b>KTFR-319R</b><br/>KIT FRENOS (R) FORD MARQUIS EXPLORER 95-</p>              |
|  <p><b>KTFR-313R</b><br/>KIT FRENOS (R) FORD RANGER 95-02</p>                       |  <p><b>KTFR-322R</b><br/>KIT FRENOS (R) FORD RANGER 95-02</p>         |  <p><b>KTFR-310R</b><br/>KIT FRENOS (R) FORD WINDSTAR 93-95 NISSAN QUEST 93-01</p> |



## FRENOS



**KTFR-315R**  
KIT FRENOS (R) FORD WINDSTAR 95-01



**KTFR-314**  
KIT FRENOS (R/L) FORD F450 05-10



**3730-FORD**  
TUBO FRENO FORD RANGER 30"



**3751-FORD**  
TUBO FRENO FORD RANGER 51"



**3760-FORD**  
TUBO FRENO FORD RANGER 60"



**3770-FORD**  
TUBO FRENO FORD RANGER 70"



**3780-FORD**  
TUBO FRENO FORD RANGER 80"



**3012-GM**  
TUBO FRENO GM FORD DODGE TODOS 12"



**3020-GM**  
TUBO FRENO GM FORD DODGE TODOS 20"



**3030-GM**  
TUBO FRENO GM FORD DODGE TODOS 30"



**3040-GM**  
TUBO FRENO GM FORD DODGE TODOS 40"



**3051-GM**  
TUBO FRENO GM FORD DODGE TODOS 51"



**3060-GM**  
TUBO FRENO GM FORD DODGE TODOS 60"



**3070-GM**  
TUBO FRENO GM FORD DODGE TODOS 70"



**3080-GM**  
TUBO FRENO GM FORD DODGE TODOS 80"



## FUEL INJECTION

|  |   |   |
|--|---|---|
| <p><b>AC-21</b><br/>VALVULA IAC FORD</p>   |  <p><b>ISC-V19</b><br/>VALVULA IAC FORD BRONCO COUGAR MUSTANG</p>  |  <p><b>ISC-V10</b><br/>VALVULA IAC FORD EXPEDITION CAMIONETAS</p>                          |
|  <p><b>ISC-V22</b><br/>VALVULA IAC FORD F150 F250 F350 97-01</p>  |  <p><b>GC-098</b><br/>VALVULA IAC FORD FIESTA 1.6 98 A/A IMPOR</p> |  <p><b>GC-097</b><br/>VALVULA IAC FORD FIESTA IKON 1.6</p>                                 |
|  <p><b>ISC-V13</b><br/>VALVULA IAC FORD GRAN MARQUIS 95 4.6L</p> |  <p><b>GC-046</b><br/>VALVULA IAC FORD RANGER -7-02</p>           |  <p><b>GC-045</b><br/>VALVULA IAC FORD RANGER 89-96 CONTOUR<br/>ESCORT BRONCO MUSTANG</p> |
|  <p><b>ISC-V16</b><br/>VALVULA IAC FORD RANGER CAMIONETA</p>    |   |   |



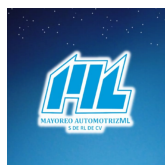

## GOMAS

|   |  |   |
|---|--|---|
| <p>Código: BAFIGO</p>  <p><b>BA-FIGO</b><br/>BUJE BARRA ESTABILIZADORA FORD FIGO</p>                             | <p>Código: CAL32AL</p>  <p><b>CAL32AL</b><br/>CALZA FORD 1 ALUMINIO</p>                                 | <p>Código: CAL33AL</p>  <p><b>CAL33AL</b><br/>CALZA FORD 3/4 ALUMINIO</p>                                    |
| <p>Código: CAL1912AL</p>  <p><b>CAL1912AL</b><br/>CALZA FORD ALUMINIO</p>  | <p>Código: JGB-7021</p>  <p><b>JGB-7021</b><br/>GOMA BARRA ESTABILIZADORA FORD G SUPER DUTY</p>         | <p>Código: POL-BAFORDGD</p>  <p><b>POL-BAFORDGD</b><br/>GOMA BARRA ESTABILIZADORA FORD G SUPER DUTY</p>      |
| <p>Código: BACONT</p>  <p><b>BACONT</b><br/>GOMA BARRA ESTABILIZADORA CONTOUR FORD FIESTA</p>                   | <p>Código: POL-BACONT</p>  <p><b>POL-BACONT</b><br/>GOMA BARRA ESTABILIZADORA CONTOUR FORD FIESTA</p>  | <p>Código: BACONTD01</p>  <p><b>BACONTD01</b><br/>GOMA BARRA ESTABILIZADORA FORD CONTOUR DELANTERA 95-01</p> |
| <p>Código: BAECOSPD17</p>  <p><b>BAECOSPD17</b><br/>GOMA BARRA ESTABILIZADORA FORD ECOSPORT DELANTERO 13-17</p> | <p>Código: BAEDGE</p>  <p><b>BAEDGE</b><br/>GOMA BARRA ESTABILIZADORA FORD EDGE</p>                   | <p>Código: POL-BAEDGE</p>  <p><b>POL-BAEDGE</b><br/>GOMA BARRA ESTABILIZADORA FORD EDGE</p>                |
| <p>Código: BAEDGE06</p>  <p><b>BAEDGE06</b><br/>GOMA BARRA ESTABILIZADORA FORD EDGE 06-09</p>                  | <p>Código: POL-BAEDGE06</p>  <p><b>POL-BAEDGE06</b><br/>GOMA BARRA ESTABILIZADORA FORD EDGE 06-09</p> | <p>Código: BAEDGE07</p>  <p><b>BAEDGE07</b><br/>GOMA BARRA ESTABILIZADORA FORD EDGE 07-14</p>              |







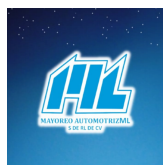

## GOMAS

|   |  |   |
|---|--|---|
| <p>Código: POL-BAEDGE07</p>  <p><b>POL-BAEDGE07</b><br/>GOMA BARRA ESTABILIZADORA FORD EDGE 07-14</p>      | <p><b>BAESCD04</b><br/>GOMA BARRA ESTABILIZADORA FORD ESCAPE DELANTERA 00-04</p>   | <p><b>BAESCAPET05</b><br/>GOMA BARRA ESTABILIZADORA FORD ESCAPE TRASERA 01-05</p>   |
| <p><b>BAEX4WDEL</b><br/>GOMA BARRA ESTABILIZADORA FORD EXPLORER 4WD DELANTERA 29 MM</p>   | <p><b>BAF250T17</b><br/>GOMA BARRA ESTABILIZADORA FORD F250 TRASERA 08-17</p>  | <p>Código: BAFIESTA</p>  <p><b>BAFIESTA</b><br/>GOMA BARRA ESTABILIZADORA FORD FIESTA</p>              |
| <p>Código: POL-BAFIESTA</p>  <p><b>POL-BAFIESTA</b><br/>GOMA BARRA ESTABILIZADORA FORD FIESTA</p>        | <p><b>BAFIESD11</b><br/>GOMA BARRA ESTABILIZADORA FORD FIESTA 98-11 DELANTERA</p>  | <p>Código: BAFIESBA</p>  <p><b>BAFIESBA</b><br/>GOMA BARRA ESTABILIZADORA FORD FIESTA BARRIL</p>     |
| <p>Código: POL-BAFIESBA</p>  <p><b>POL-BAFIESBA</b><br/>GOMA BARRA ESTABILIZADORA FORD FIESTA BARRIL</p> | <p>Código: POL-BAFIGO</p>  <p><b>POL-BAFIGO</b><br/>GOMA BARRA ESTABILIZADORA FORD FIGO</p> | <p><b>BAFIGOGDE</b><br/>GOMA BARRA ESTABILIZADORA FORD FIGO GRANDE</p>  |
| <p><b>BAFOCUDL18</b><br/>GOMA BARRA ESTABILIZADORA FORD FOCUS DELANTERA 12-18</p>   | <p><b>BAFOCUSTR18</b><br/>GOMA BARRA ESTABILIZADORA FORD FOCUS TRASERA 12-18</p>   | <p>Código: BAFIES98</p>  <p><b>BAFIES98</b><br/>GOMA BARRA ESTABILIZADORA FORD FORD FIESTA 98-11</p> |



## GOMAS

|   |  |  |
|---|--|--|
| <p>Código: POL-BAFIES98</p>  <p><b>POL-BAFIES98</b><br/>GOMA BARRA ESTABILIZADORA FORD FORD FIESTA 98-11</p> | <p>Código: BAFREESTAR08</p>  <p><b>BAFREESTAR08</b><br/>GOMA BARRA ESTABILIZADORA FORD FREESTAR DELANTERO 04-08</p> | <p>Código: BAFOK</p>  <p><b>BAFOK</b><br/>GOMA BARRA ESTABILIZADORA FORD K CONTOUR</p>                      |
| <p>Código: POL-BAFOK</p>  <p><b>POL-BAFOK</b><br/>GOMA BARRA ESTABILIZADORA FORD K CONTOUR</p>               | <p>Código: BALOB21</p>  <p><b>BALOB21</b><br/>GOMA BARRA ESTABILIZADORA FORD LOBO 15-21</p>                         | <p>Código: BALOB97</p>  <p><b>BALOB97</b><br/>GOMA BARRA ESTABILIZADORA FORD LOBO 4X2 97-02</p>             |
| <p>Código: BAFORDM</p>  <p><b>BAFORDM</b><br/>GOMA BARRA ESTABILIZADORA FORD MEDIANA</p>                    | <p>Código: POL-BAFORDM</p>  <p><b>POL-BAFORDM</b><br/>GOMA BARRA ESTABILIZADORA FORD MEDIANA</p>                   | <p>Código: BAMOND07</p>  <p><b>BAMOND07</b><br/>GOMA BARRA ESTABILIZADORA FORD MONDEO 00-07 DELANTERA</p>  |
| <p>Código: BAMONTR07</p>  <p><b>BAMONTR07</b><br/>GOMA BARRA ESTABILIZADORA FORD MONDEO TRASERA 00-07</p>  | <p>Código: BAMUST30MM</p>  <p><b>BAMUST30MM</b><br/>GOMA BARRA ESTABILIZADORA FORD MUSTANG 30 MM 09</p>           | <p>Código: BARANMAZ12</p>  <p><b>BARANMAZ12</b><br/>GOMA BARRA ESTABILIZADORA FORD RANGER-MAZDA 92-12</p> |
| <p>Código: BAFORTR</p>  <p><b>BAFORTR</b><br/>GOMA BARRA ESTABILIZADORA FORD TRANSIT</p>                   | <p>Código: POL-BAFORTR</p>  <p><b>POL-BAFORTR</b><br/>GOMA BARRA ESTABILIZADORA FORD TRANSIT</p>                  | <p>Código: BAWINDS</p>  <p><b>JGB-7002</b><br/>GOMA BARRA ESTABILIZADORA FORD WINDSTAR</p>                |



## GOMAS

|  |   |  |
|--|---|--|
| <p>Código: POL-BAWINDS</p>  <p><b>POL-BAWINDS</b><br/>GOMA BARRA ESTABILIZADORA FORD WINDSTAR</p> | <p><b>BAFORD21</b><br/>GOMA BARRA ESTABILIZADORA KIA FORTE DELANTERO 14-21</p>  | <p><b>MOFORD</b><br/>GOMA MOFLE FORD</p>   |
| <p>Código: MOFIE</p>  <p><b>MOFIE</b><br/>GOMA MOFLE FORD FIESTA</p>                              | <p>Código: POL-MOFIE</p>  <p><b>POL-MOFIE</b><br/>GOMA MOFLE FORD FIESTA</p>       | <p>Código: MOIKON</p>  <p><b>MOIKON</b><br/>GOMA MOFLE FORD IKON</p>                              |
| <p>Código: POL-MOIKON</p>  <p><b>POL-MOIKON</b><br/>GOMA MOFLE FORD IKON</p>                     | <p><b>MOMONDEO</b><br/>GOMA MOFLE FORD MONDEO FOCUS</p>   | <p>Código: POL-RADFOCFI</p>  <p><b>POL-RADFOCFI</b><br/>GOMA RADIADOR FORD FOCUS FIESTA IKON</p> |
| <p>Código: RADFOCFI</p>  <p><b>RADFOCFI</b><br/>GOMA RADIADOR FORD FOCUS FIESTA IKON</p>        | <p>Código: GOTORF</p>  <p><b>GOTORF</b><br/>GOMA TORNILLO FORD</p>               | <p>Código: POL-GOTORF</p>  <p><b>POL-GOTORF</b><br/>GOMA TORNILLO FORD</p>                      |
| <p>Código: POL-TIRF8295</p>  <p><b>POL-TIRF8295</b><br/>JUEGO BUJE TIRANTE FORD 8295</p>        | <p>Código: TIRF8295</p>  <p><b>TF-8295E</b><br/>JUEGO BUJE TIRANTE FORD 8295</p> | <p>Código: JUCUEFORD</p>  <p><b>JUCUEFORD</b><br/>JUEGO CUENCAS MAROMA LA BATEA FORD</p>        |



## GOMAS

Código: REBRANGER



**REBRANGER**  
REBOTE FORD RANGER

Código: TOPCOFIGO



**TORCOFIGO**  
TOPE NIVELADOR COFRE FORD FIGO



**TOR-FRD-11**  
TORNILLO ESTABILIZADOR FORD RANGER 11



## LOTE

|  |   |  |
|--|---|--|
| <b>BQ-8162</b><br>BOBINA DE ENCENDIDO FORD EXPLORER 4.0L<br>93-06 RANGER 96-00 | <b>BQ-8121</b><br>BOBINA DE ENCENDIDO FORD WINDSTAR | <b>ML-210-P</b><br>PISTON CALIPER C/LIGA FORD ESCAPE 01-03 |
| <b>M0-271</b><br>REGULADOR FORD 90AMP TAURUS                                   | <b>B0-235</b><br>REGULADOR FORD KA COURIER FIESTA   | <b>B0-220</b><br>REGULADOR FORD KA COURRIER FIESTA         |



## MANGUERAS



**ATB204619**  
MANGUERA FRENO DELANTERO DER FORD  
AEROSTAR 91-95



**ATB204692**  
MANGUERA FRENO DELANTERO DER FORD  
EXPLORER 93-94



**ATB204693**  
MANGUERA FRENO DELANTERO DER FORD  
EXPLORER LIMITED 92



**ATB200052**  
MANGUERA FRENO DELANTERO DER FORD  
EXPLORER XLS-V6 FORD EXPLORER XLS V6 XLT  
V8 LIMITED



**ATB204006**  
MANGUERA FRENO DELANTERO DER FORD F350  
73-75



**ATB204062**  
MANGUERA FRENO DELANTERO DER FORD  
TOPAZ 84-94



**ATB204004**  
MANGUERA FRENO DELANTERO DER/IZQ FORD  
F-100 150 73-79



**ATB201181**  
MANGUERA FRENO DELANTERO DER/IZQ FORD  
MUSTANG 79-84



**ATB2041035**  
MANGUERA FRENO DELANTERO DER/IZQ FORD  
S-10 FORD S10 PICK UP 00-04



**ATB200039**  
MANGUERA FRENO DELANTERO FORD EXPLORER  
V6 V8 LH



**ATB2041010**  
MANGUERA FRENO DELANTERO IZQ FORD 250  
95-97 350 95-98



**ATB204618**  
MANGUERA FRENO DELANTERO IZQ FORD  
AEROSTAR 91-95



**ATB204691**  
MANGUERA FRENO DELANTERO IZQ FORD  
EXPLORER 93-94



**ATB200051**  
MANGUERA FRENO DELANTERO IZQ FORD  
EXPLORER XLS V6 FORD EXPLORER XLS V6 XLT  
V8 LIMITED



**ATB204063**  
MANGUERA FRENO DELANTERO IZQ FORD TOPAZ  
84-94



## MANGUERAS



**ATB204272**

MANGUERA FRENO DELANTERO IZQ FORD TRK  
1/2 SERIE 77-76



**ATB204628**

MANGUERA FRENO FORD WINDSTAR TRACKER  
98-95



**ATB201370**

MANGUERA FRENO FORD WINSTARD GL. LX  
FORD WINSTAR GL. LX FFRENOS TAMBOR 95-03



**ATB201371**

MANGUERA FRENO FORD WINSTARD GL. LX  
FORD WINSTAR GL. LX FFRENOS TAMBOR 95-03

















**ATB205176**

MANGUERA FRENO TRASERO FORD 97-04  
LOBO97-99



## MANGUERAS CAUPLAS

|   |  |  |
|---|--|--|
|  <p><b>5934</b><br/>MANGUERA CALEFACCION ENTRADA FORD FIESTA 03-10</p>                     |  <p><b>4136</b><br/>MANGUERA CALEFACCION FORD COURIER 01-12 FIESTA 01-02</p>  |  <p><b>3772</b><br/>MANGUERA CALEFACCION FORD F100 01 RANGER 01-02</p>        |
|  <p><b>11177</b><br/>MANGUERA CALEFACCION FORD FIESTA 11-17</p>                            |  <p><b>11216</b><br/>MANGUERA CALEFACCION FORD FIESTA 11-17</p>               |  <p><b>4093</b><br/>MANGUERA CALEFACCION FORD FOCUS 00-03</p>                 |
|  <p><b>3732</b><br/>MANGUERA CALEFACCION FORD INFINITI I30 96-99</p>                      |  <p><b>3721</b><br/>MANGUERA CALEFACCION FORD MUSTANG 64-68 72-73</p>        |  <p><b>3727</b><br/>MANGUERA CALEFACCION FORD TOPAZ 92-94</p>                |
|  <p><b>5809</b><br/>MANGUERA CALEFACCION MOTOR FORD E150 79-96 E200 69-74 E250 79-91</p> |  <p><b>4130</b><br/>MANGUERA CALEFACCION MULTIPLE ADM FORD TAURUS 69-99</p> |  <p><b>3754</b><br/>MANGUERA CALEFACCION SALID FORD ECOSPORT 1.4L 03-12</p> |
|  <p><b>5673</b><br/>MANGUERA CALEFACCION SALIDA FORD COURIER 01-12 FIESTA 01-02</p>      |  <p><b>3756</b><br/>MANGUERA CALEFACCION SALIDA FORD FIESTA 02-10</p>       |  <p><b>11175</b><br/>MANGUERA CALEFACCION SALIDA FORD FIESTA 11-17</p>      |



## MANGUERAS CAUPLAS

|  |  |   |
|--|--|---|
|  <p><b>3758</b><br/>MANGUERA COMBUSTIBLE FORD ECOSPORT<br/>11-15 FIESTA 03-10</p>     |  <p><b>3767</b><br/>MANGUERA COMBUSTIBLE FORD ECOSPORT 2.0L<br/>04-12</p>             |  <p><b>11016</b><br/>MANGUERA COMBUSTIBLE FORD FIESTA 11-17</p>                    |
|  <p><b>3581</b><br/>MANGUERA COMBUSTIBLE TANQUE FORD<br/>RANGER 93-07</p>             |  <p><b>3883</b><br/>MANGUERA DESC GASES FORD RANGER 4.0L<br/>98-01</p>                |  <p><b>4089</b><br/>MANGUERA DESCARGA FORD FOCUS 00-04</p>                         |
|  <p><b>3856</b><br/>MANGUERA DESCARGA GASES FORD FIESTA<br/>98-00</p>                |  <p><b>11316</b><br/>MANGUERA FORD BRONCO 5.8L 93-96 RADIADOR<br/>INF</p>            |  <p><b>11410</b><br/>MANGUERA FORD CROWN VICTORIA 4.6L 98-02<br/>RADIADOR SUP</p> |
|  <p><b>11346</b><br/>MANGUERA FORD E-350 SUPER DUTY 7.3L 02-03<br/>RADIADOR INF</p> |  <p><b>11345</b><br/>MANGUERA FORD E-450 SUPER DUTY 7.3L 01<br/>RADIADOR INF</p>    |  <p><b>11342</b><br/>MANGUERA FORD E150 4.6L 03-04 07-12<br/>RADIADOR INF</p>    |
|  <p><b>19129</b><br/>MANGUERA FORD E150 4.9L 81-87 PASO TUBO A<br/>TERM</p>         |  <p><b>11176</b><br/>MANGUERA FORD ECOSPORT 2.0 04-12 DESC<br/>VENTEO DE CARTER</p> |  <p><b>11355</b><br/>MANGUERA FORD EDGE 2.0L 12-15 RADIADOR<br/>SUP</p>          |



## MANGUERAS CAUPLAS

|  |   |   |
|--|---|---|
|  <p><b>11353</b><br/>MANGUERA FORD EXPLORER 2.0L 12-15<br/>RADIADOR SUP</p>             |  <p><b>11354</b><br/>MANGUERA FORD EXPLORER 3.5L 13-<br/>RADIADOR SUP</p>          |  <p><b>11349</b><br/>MANGUERA FORD F150 4.2L 05-08<br/>RADIADOR INF</p>  |
|  <p><b>11312</b><br/>MANGUERA FORD F150 4.2L 97-04<br/>CALEFACCION SAL</p>              |  <p><b>3922</b><br/>MANGUERA FORD F150 5.0L 90-95<br/>RADIADOR INF</p>             |  <p><b>3907</b><br/>MANGUERA FORD F150 5.0L 96<br/>RADIADOR INF</p>  |
|  <p><b>11356</b><br/>MANGUERA FORD F150-LOBO 5.0L<br/>11-14 RADIADOR INF</p>           |  <p><b>11368</b><br/>MANGUERA FORD F150-LOBO 5.0L<br/>11-21 PASO TERM A MOT</p>   |  <p><b>11235</b><br/>MANGUERA FORD FOCUS 2.0L 00-04<br/>COMB LLENADO</p>                                      |
|  <p><b>11413</b><br/>MANGUERA FORD FOCUS 2.0L 01-03<br/>CALEFACCION TERM A TUBO</p>   |  <p><b>5982</b><br/>MANGUERA FORD FOCUS 2.0L 08-13<br/>COMB LLENADO</p>          |  <p><b>11350</b><br/>MANGUERA FORD FUSION 2.5L 10-12<br/>RADIADOR INF</p>                                    |
|  <p><b>11351</b><br/>MANGUERA FORD FUSION 2.5L 10-12<br/>RADIADOR INFERIOR HYBRID</p> |  <p><b>11358</b><br/>MANGUERA FORD GRAND MARQUIS<br/>4.6L 03-04 RADIADOR INF</p> |  <p><b>11344</b><br/>MANGUERA FORD GRAND MARQUIS<br/>4.6L 03-04 RADIADOR INFERIOR<br/>RADIADOR A ENF ACE</p> |





## MANGUERAS CAUPLAS



**11423**  
MANGUERA FORD GRAND MARQUIS 4.6L 98-02  
RADIADOR INFERIOR RADIADOR A ENF ACE



**19140**  
MANGUERA FORD LTD CROWN VICTORIA 5.0L  
87-91 PASO TUBO A BOM



**11437**  
MANGUERA FORD MUSTANG 3.8L 94-04  
RADIADOR INF



**11343**  
MANGUERA FORD MUSTANG 4.0L 05-10  
RADIADOR INF



**11348**  
MANGUERA FORD MUSTANG 4.6L 07-09  
RADIADOR INF



**11352**  
MANGUERA FORD MUSTANG 4.6L 10 RADIADOR  
INF



**11027**  
MANGUERA FORD RANGER 2.3L 01-11  
CALEFACCION VALV A CALEF



**7808**  
MANGUERA FORD RANGER 2.3L 93-97 COMB  
LLENADO CORTA



**5802**  
MANGUERA FORD RANGER 2.3L 93-97 COMB  
LLENADO LARGA



**11347**  
MANGUERA FORD RANGER 3.0L 04-08 RADIADOR  
INF



**11396**  
MANGUERA FORD RANGER 3.2L 17- DESC  
GASOLINA RESPIRADOR



**11341**  
MANGUERA FORD THUNDERBIRD 4.6L 94-97  
RADIADOR INF



**11304**  
MANGUERA FORD TRANSIT 2.2L 12-14 PASO A  
DEP

















**11414**  
MANGUERA FORD WINDSTAR 3.8L 95-96  
RADIADOR INF



**3750**  
MANGUERA GASES FORD FIESTA 03-10

## MANGUERAS CAUPLAS

|   |  |  |
|---|--|--|
|  <p><b>5662</b><br/>MANGUERA LUBRICACION FORD COURIER 01-12<br/>FIESTA 01-02</p>               |  <p><b>3747</b><br/>MANGUERA LUBRICACION FORD FIESTA 03-10</p>                    |  <p><b>11213</b><br/>MANGUERA RADIADOR FORD FIGO 16-19</p>                        |
|  <p><b>5521</b><br/>MANGUERA RADIADOR GM AVEO 07-18 FORD<br/>FUSION 13-15 PONTIAC G3 07-09</p> |  <p><b>3895</b><br/>MANGUERA RADIADOR INFERIOR DOHC FORD<br/>FOCUS 00-04</p>      |  <p><b>3950</b><br/>MANGUERA RADIADOR INFERIOR FORD<br/>CONTOUR 2.0L 98-00</p>    |
|  <p><b>5602</b><br/>MANGUERA RADIADOR INFERIOR FORD COURIER<br/>01-02</p>                     |  <p><b>3464</b><br/>MANGUERA RADIADOR INFERIOR FORD COURIER<br/>03-12</p>       |  <p><b>3893</b><br/>MANGUERA RADIADOR INFERIOR FORD E100<br/>E200 E300 72-74</p> |
|  <p><b>3463</b><br/>MANGUERA RADIADOR INFERIOR FORD<br/>ECOSPORT 04-12</p>                   |  <p><b>5741</b><br/>MANGUERA RADIADOR INFERIOR FORD ESCAPE<br/>3.0L 01-04</p>   |  <p><b>3962</b><br/>MANGUERA RADIADOR INFERIOR FORD ESCORT<br/>91-02</p>        |
|  <p><b>3978</b><br/>MANGUERA RADIADOR INFERIOR FORD<br/>EXPEDITION 4.6 97-02</p>             |  <p><b>3871</b><br/>MANGUERA RADIADOR INFERIOR FORD<br/>EXPLORER 5.0L 99-01</p> |  <p><b>3739</b><br/>MANGUERA RADIADOR INFERIOR FORD F100<br/>RANGER 96-97</p>   |

















## MANGUERAS CAUPLAS

|   |   |   |
|---|---|---|
|  <p><b>3880</b><br/>MANGUERA RADIADOR INFERIOR FORD F150<br/>3.8L 94-96</p>    |  <p><b>3970</b><br/>MANGUERA RADIADOR INFERIOR FORD F150 4.2L<br/>97-04</p>          |  <p><b>5845</b><br/>MANGUERA RADIADOR INFERIOR FORD FIESTA<br/>00-02</p>             |
|  <p><b>3763</b><br/>MANGUERA RADIADOR INFERIOR FORD FIESTA<br/>03-10</p>       |  <p><b>5985</b><br/>MANGUERA RADIADOR INFERIOR FORD FIESTA<br/>03-10</p>             |  <p><b>11005</b><br/>MANGUERA RADIADOR INFERIOR FORD FIESTA<br/>11-17</p>            |
|  <p><b>3796</b><br/>MANGUERA RADIADOR INFERIOR FORD<br/>FREESTAR 04-07</p>    |  <p><b>11115</b><br/>MANGUERA RADIADOR INFERIOR FORD IKON<br/>03-07</p>             |  <p><b>3484</b><br/>MANGUERA RADIADOR INFERIOR FORD IKON<br/>03-07</p>              |
|  <p><b>5958</b><br/>MANGUERA RADIADOR INFERIOR FORD IKON<br/>1.6L 03-07</p>  |  <p><b>4132</b><br/>MANGUERA RADIADOR INFERIOR FORD KA 02-07</p>                   |  <p><b>11412</b><br/>MANGUERA RADIADOR INFERIOR FORD RANGER<br/>2.3L 90-94</p>     |
|  <p><b>2717</b><br/>MANGUERA RADIADOR INFERIOR FORD RANGER<br/>3.0 91-92</p> |  <p><b>3651</b><br/>MANGUERA RADIADOR INFERIOR FORD<br/>THUNDERBIRD 5.0L 91-93</p> |  <p><b>3523</b><br/>MANGUERA RADIADOR INFERIOR GM 1500 HD<br/>01-03 FORD 00-04</p> |







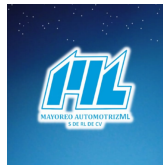









## MANGUERAS CAUPLAS

|  |  |  |
|--|--|--|
|  <p><b>3737</b><br/>MANGUERA RADIADOR INFERIOR TRANS MAN<br/>FORD RANGER 90-92</p>    |  <p><b>4133</b><br/>MANGUERA RADIADOR INFERIOR TUBO A MOTOR<br/>FORD KA 02-07</p>     |  <p><b>3778</b><br/>MANGUERA RADIADOR SUPERIOR C/AA FORD<br/>WINDSTAR 96-03</p>     |
|  <p><b>5600</b><br/>MANGUERA RADIADOR SUPERIOR FORD COURIER<br/>03-12</p>             |  <p><b>3967</b><br/>MANGUERA RADIADOR SUPERIOR FORD CROWN<br/>VICTORIA 4.6L 98-02</p> |  <p><b>3971</b><br/>MANGUERA RADIADOR SUPERIOR FORD E150<br/>ECOLINE 4.2L 97-03</p> |
|  <p><b>3655</b><br/>MANGUERA RADIADOR SUPERIOR FORD E200<br/>E300 69-70</p>          |  <p><b>3753</b><br/>MANGUERA RADIADOR SUPERIOR FORD<br/>ECOSPORT 04-12</p>           |  <p><b>5742</b><br/>MANGUERA RADIADOR SUPERIOR FORD ESCAPE<br/>01-04</p>           |
|  <p><b>11291</b><br/>MANGUERA RADIADOR SUPERIOR FORD ESCAPE<br/>3.0L 04-05</p>      |  <p><b>3551</b><br/>MANGUERA RADIADOR SUPERIOR FORD<br/>EXPEDITION 97-02 03-04</p>  |  <p><b>3798</b><br/>MANGUERA RADIADOR SUPERIOR FORD<br/>EXPLORER 4.0L 01-03</p>   |
|  <p><b>3492</b><br/>MANGUERA RADIADOR SUPERIOR FORD F-100<br/>RANGER 4.0L 95-97</p> |  <p><b>3976</b><br/>MANGUERA RADIADOR SUPERIOR FORD F150<br/>4.2L 97-04</p>         |  <p><b>5799</b><br/>MANGUERA RADIADOR SUPERIOR FORD F150<br/>4.6L 04-08</p>       |

















## MANGUERAS CAUPLAS

|  |  |  |
|--|--|--|
|  <p><b>3498</b><br/>MANGUERA RADIADOR SUPERIOR FORD F150<br/>4.9L 85-89</p>     |  <p><b>3920</b><br/>MANGUERA RADIADOR SUPERIOR FORD F250<br/>95-97 F350 95-96</p> |  <p><b>3517</b><br/>MANGUERA RADIADOR SUPERIOR FORD FIESTA<br/>03-10</p>        |
|  <p><b>5789</b><br/>MANGUERA RADIADOR SUPERIOR FORD FIESTA<br/>03-10</p>        |  <p><b>3459</b><br/>MANGUERA RADIADOR SUPERIOR FORD FIESTA<br/>1.6L 04-10</p>     |  <p><b>11015</b><br/>MANGUERA RADIADOR SUPERIOR FORD FIESTA<br/>11-17</p>       |
|  <p><b>4017</b><br/>MANGUERA RADIADOR SUPERIOR FORD FIESTA<br/>98-00</p>       |  <p><b>3801</b><br/>MANGUERA RADIADOR SUPERIOR FORD FIESTA<br/>98-01</p>        |  <p><b>11214</b><br/>MANGUERA RADIADOR SUPERIOR FORD FIGO<br/>16-19</p>        |
|  <p><b>11294</b><br/>MANGUERA RADIADOR SUPERIOR FORD IKON<br/>03-07</p>       |  <p><b>3908</b><br/>MANGUERA RADIADOR SUPERIOR FORD KA 01-07</p>                |  <p><b>4129</b><br/>MANGUERA RADIADOR SUPERIOR FORD KA 1.0<br/>01-08</p>      |
|  <p><b>3866</b><br/>MANGUERA RADIADOR SUPERIOR FORD RANGER<br/>2.3L 90-94</p> |  <p><b>3738</b><br/>MANGUERA RADIADOR SUPERIOR FORD RANGER<br/>2.3L 95-97</p>   |  <p><b>5995</b><br/>MANGUERA RADIADOR SUPERIOR FORD RANGER<br/>2.5L 13-18</p> |



## MANGUERAS CAUPLAS

|   |   |   |
|---|---|---|
|  <p><b>3791</b><br/>MANGUERA RADIADOR SUPERIOR FORD RANGER<br/>93-97 MAZDA B3000 95-03</p> |  <p><b>3909</b><br/>MANGUERA RADIADOR SUPERIOR OHV FORD<br/>EXPLORER 4.0L 95-00</p>        |  <p><b>3520</b><br/>MANGUERA RADIADOR SUPERIOR S/AA FORD<br/>WINDSTAR 96-03</p>        |
|  <p><b>3894</b><br/>MANGUERA RADIADOR SUPERIOR SOHC FORD<br/>FOCUS 00-04</p>               |  <p><b>5135</b><br/>MANGUERA REFRIGERACION C/AA GM ASTRO<br/>90-92 FORD WINDSTAR 96-00</p> |  <p><b>5604</b><br/>MANGUERA REFRIGERACION DEPOSITO FORD<br/>FIESTA 03-10</p>          |
|  <p><b>3794</b><br/>MANGUERA REFRIGERACION FORD CONTOUR<br/>95-00 WINDSTAR 95-96</p>      |  <p><b>3462</b><br/>MANGUERA REFRIGERACION FORD COURIER<br/>01-12 FIESTA 01</p>          |  <p><b>3765</b><br/>MANGUERA REFRIGERACION FORD FIESTA 01-02<br/>IKON 03-07</p>       |
|  <p><b>5959</b><br/>MANGUERA REFRIGERACION FORD FIESTA 02-10</p>                         |  <p><b>5986</b><br/>MANGUERA REFRIGERACION FORD FIESTA 03-10</p>                         |  <p><b>11006</b><br/>MANGUERA REFRIGERACION FORD FIESTA 11-17</p>                    |
|  <p><b>11219</b><br/>MANGUERA REFRIGERACION FORD FIESTA 11-17</p>                        |  <p><b>11221</b><br/>MANGUERA REFRIGERACION FORD FIGO 16-19</p>                          |  <p><b>5807</b><br/>MANGUERA REFRIGERACION MULTIPLE DE ADM<br/>FORD ESCAPE 01-04</p> |





## MANGUERAS CAUPLAS

|  |  |  |
|--|--|--|
|  <p><b>3724</b><br/>MANGUERA REFRIGERACION PASO FORD F100<br/>82-82 MUSTANG 83-86</p> |  <p><b>3800</b><br/>MANGUERA REFRIGERACION PASO FORD F150<br/>92-96</p>     |  <p><b>3050</b><br/>MANGUERA REFRIGERACION PASO FORD F250<br/>F350 SUPER DUTY 03-04</p> |
|  <p><b>3729</b><br/>MANGUERA REFRIGERACION PASO FORD TOPAZ<br/>88-91</p>              |  <p><b>5926</b><br/>MANGUERA REFRIGERACION PIPETA FORD FIESTA<br/>03-10</p> |  <p><b>3752</b><br/>MANGUERA VENTILACION FORD ECOSPORT 04-12<br/>FIESTA 03-10</p>       |
|  <p><b>11535</b><br/>TOMA AIRE FORD CONTOUR 95-00</p>                                |  <p><b>11536</b><br/>TOMA AIRE FORD RANGER 2.3L 05-15</p>                  |  <p><b>11537</b><br/>TOMA AIRE FORD RANGER 3.0L 92-94</p>                             |
|  <p><b>11538</b><br/>TOMA AIRE FORD RANGER 4.0L 92-94</p>                           |  <p><b>11539</b><br/>TOMA AIRE FORD WINDSTAR 3.8L 95-03</p>               |  <p><b>11388</b><br/>VALVULA CALEFACCION FORD FIESTA 04-10</p>                        |



## MAZAS



**MZ-FRD-311**

MAZA RUEDA DELANTERO FORD 4 B ESCORT  
94-02



**MZ-FRD-323**

MAZA RUEDA DELANTERO FORD 4 B  
MYSTIQ/CONT 95-00



**MZ-FRD-322**

MAZA RUEDA DELANTERO S/ABS FORD FIESTA  
98-02 FIGO 16-20 IKON 98-10 KA 01-08  
ECOSPORT



**MZ-FRD-326**

MAZA RUEDA TRASERO FORD FIESTA 98-02



## MISCELANEOS



**P-1294**  
PALANCA VELOCIDADES FORD RANGER



**R-1294-A**  
REPUESTO PALANCA VELOCIDADES FORD  
RANGER 87-92



# NIKKO

**K-8687B**

ROTULA FORD SABLE TAURUS 96-04 INF

**1011858-L**

TERMINAL DIRECC FORD FIESTA EXT 98-02 IZQ  
(OFERTA)



## POLEAS



**FW-005**

POLEA MOTOR FORD ASPIRE VILLAGER (GATES 38044)

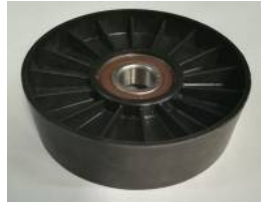

**FW-040**

POLEA MOTOR FORD CAVALIER CELEBRITY AEROSTAR RANGER EXPLORE



**FW-052**

POLEA MOTOR FORD EXPEDITION 97-02 F-250 4.6L F-350 5.4L



**FW-017**

POLEA MOTOR FORD MUSTANG 2.3L SUBURBAN 7.4L CYK SERIES 7.4L



**FW-031**

POLEA MOTOR LISA FORD CAVALIER 00-02 2.4L TEMPO

## SENSORES



**74-9555**  
SENSOR MAF FORD RANGER EXPLORER



**E007**  
SENSOR OXIGENO FORD



## STRUNKER



### KFO460

KIT CLUTCH FORD AEROSTAR 4L 2.3L V6 2.8L V6 3.0L (86-87) BRONCO II RANGER V6 2.8L (19



### KFO470

KIT CLUTCH FORD AEROSTAR V6 3.0L (88-92) BRONCO II V6 2.9L (88-90) RANGER 4L 2.0L (88)



### KFO483

KIT CLUTCH FORD AEROSTAR V6 3.0L (88-94) RANGER V6 3.0L (93-94) B3000 V6 3.0L (1994)



### KFO479

KIT CLUTCH FORD B2300 4L 2.3L (95-96) B2300 4L 2.3L (01-09) B2500 4L 2.5L (98-01) B30



### KFO473

KIT CLUTCH FORD B4000 V6 4.0L (94-97) NAVAJO V6 4.0L (93-94) EXPLORER RANGER V6 4.0L



### KFO499HNA

KIT CLUTCH FORD BRONCO I 6L 4.9L (87-92) BRONCO I V8 5.8L (88-89) E-100 E-150 E-250 6



### KFO498

KIT CLUTCH FORD BRONCO I F-100 F-250 V6 3.8L (1983) BRONCO I 6L 4.9L (83-82) BRONCO I



### KFO489

KIT CLUTCH FORD BRONCO II 4L 2.0L 4L 2.3L (1984) BRONCO II V6 2.8L (84) RANGER 4L 2.0



### KFO472

KIT CLUTCH FORD COURIER 4L 1.6L (11-13) FIESTA 4L 1.6L (01-10) CSC CONECTOR 11.1MM



### KFO488

KIT CLUTCH FORD ESCORT 4L 1.9L (88-90) TEMPO TOPAZ 4L 2.3L (88-94)



### KFO475

KIT CLUTCH FORD F-100 4L 2.5L (98-03) F-100 V6 3.0L (97-03) RANGER 4L 2.3L (95-97) RA



### KFO475HAA

KIT CLUTCH FORD F-100 4L 2.5L (98-03) F-100 V6 3.0L (97-03) RANGER 4L 2.3L (95-97) RA



### KFO493

KIT CLUTCH FORD F-100 F-150 F-200 F-250 F-350 F-450 6L 5.0L (62-77) COUGAR MUSTANG V8



### KFO491

KIT CLUTCH FORD F-150 V6 3.8L (91-97) F-200 V8 5.0L (91-93) F-250 F-350 CUSTOM V8 5.0



### KFO476

KIT CLUTCH FORD F-150 V6 4.0L (94-98) RANGER V6 4.0L (90-92) B4000 NAVAJO V6 4.0L (19



## STRUNKER



**KFO478**

KIT CLUTCH FORD F-150 V6 4.2L (98-09) F-150 V8 4.6L (97-06) F-250 V8 4.6L (98-09) CON



**KFO497**

KIT CLUTCH FORD F-450 F-550 V10 6.8L (99-08)



**KFO461**

KIT CLUTCH FORD F-450 V10 6.8L (99-09) F-550 V10 6.8L (01-08)



**KFO477**

KIT CLUTCH FORD F150 L6 4.9L 95-97 F150 F250 5.8L 93-96



**KFO468**

KIT CLUTCH FORD FIESTA 4L 1.3L (98-01) BALERO

**KFO481V**

KIT CLUTCH FORD FOCUS 4L 2.0L (00-05)



**KFO469**

KIT CLUTCH FORD IKON 4L 1.6L (03-11) KA 4L 1.6L (01-08) COURIER 4L 1.6L (01-10) CSC C



**76073/TKFDT205A**

KIT DISTRIBUCION TIEMPO FORD F150 F250 4.6L 16V 98-00



**73004**

KIT DISTRIBUCION TIEMPO FORD PICK UP VAN



**TKFDT308A**

KIT DISTRIBUCION TIEMPO FORD EXPEDITION F150 5.4L 16V 98-01



**FORD 4.0-B**

KIT DISTRIBUCION TIEMPO FORD EXPLORER 4.0L 01- PICK UP 01-06



**TKFDT106B**

KIT DISTRIBUCION TIEMPO FORD FIESTA COURIER IKON 00-09



**TKFDT207A**

KIT DISTRIBUCION TIEMPO FORD TRITON 4.6 V8



**73071A**

KIT DISTRIBUCION TIEMPO FORD WINDSTAR 95-03 F150 E150 97-07

## SUSPENSION



**1408085**

BUJE HORQUILLA INFERIORIZQ DER FORD FIGO  
16-19 FIESTA 11-19 MZ MAZDA 2 12-15 CHICO



**1408084**

BUJE HORQUILLA INFERIORIZQ DER FORD FIGO  
16-19 FIESTA 11-19 MZ MAZDA 2 12-15 GRANDE



**ES-FRD-365**

ESPIGA HOMOCINETICA FORD TOPAZ 92-94



**ES-FRD-363**

ESPIGA HOMOCINETICA L/RUEDA FORD FIESTA  
98-11 IKON 98-11



**HR-FRD-311**

HORQUILLA SUSPENSION INFERIOR DER HID  
FORD FIESTA C/BUJES ROTULA



**HR-FRD-312**

HORQUILLA SUSPENSION INFERIOR IZQ HID FORD  
FIESTA C/BUJES ROTULA



**RO-FRD-01**

ROTULA FORD FIESTA IKON 98-11 COURIER  
00-11 KA 01-07



**1008038**

ROTULA INFERIOR IZQ DER FORD FIGO 16-18



**1108026**

TERMINAL EXTERIOR DER FORD FIGO 16-21  
FIESTA 11-19 ECOSPORT 13-21

## TROQUELADOS



**AB-194**  
ABRAZADERA CRUCETA DODGE FORD CAMION



**AB-186**  
ABRAZADERA CRUCETA DODGE FORD GM USA LOBO



**LA-152**  
LAINA PERNO MANGO 103 FORD CAMION (BOLSA 10PZS)



**ROND-203**  
RONDANA NARIZ FORD CAMIONETA



**ROND-214**  
RONDANA NARIZ FORD PICK UP NUEVA MICROBUS F350



**ROND-140**  
RONDANA NARIZ MANGUILLO FORD F150



**S-180**  
SEGURO MAZA FORD CAMIONETA DOBLE RODADO F350



**S-181**  
SEGURO MAZA FORD PICK UP F100



**S-192**  
SEGURO MAZA RUEDA FORD F250



**S-123-N**  
SEPARADOR BALATA 538 FORD RANGER NUEVO 98-00 VOLL 84-95



**SB-FORD**  
SOPORTE BATERIA FORD C/GANCHOS